

Pioneer

*seeing and hearing like never before**

*Voir et Entendre n'a jamais eu autant de sens

OPERATING INSTRUCTIONS
MODE D'EMPLOI
MANUAL DE INSTRUCCIONES

PDP-6020FD

PDP-5020FD

KURO
FLAT PANEL TV
TÉLÉVISEUR À ÉCRAN PLAT

FLAT PANEL TV
TÉLÉVISEUR À ÉCRAN PLAT
TELEVISOR DE PANTALLA PLANA

IMPORTANT



The lightning flash with arrowhead symbol, within an equilateral triangle, is intended to alert the user to the presence of uninsulated "dangerous voltage" within the product's enclosure that may be of sufficient magnitude to constitute a risk of electric shock to persons.

CAUTION

RISK OF ELECTRIC SHOCK
DO NOT OPEN

CAUTION:

TO PREVENT THE RISK OF ELECTRIC SHOCK, DO NOT REMOVE COVER (OR BACK). NO USER-SERVICEABLE PARTS INSIDE. REFER SERVICING TO QUALIFIED SERVICE PERSONNEL.



The exclamation point within an equilateral triangle is intended to alert the user to the presence of important operating and maintenance (servicing) instructions in the literature accompanying the appliance.

D3-4-2-1-1_En-A

IMPORTANT SAFETY INSTRUCTIONS

- 1) Read these instructions.
 - 2) Keep these instructions.
 - 3) Heed all warnings.
 - 4) Follow all instructions.
 - 5) Do not use this apparatus near water.
 - 6) Clean only with dry cloth.
 - 7) Do not block any ventilation openings. Install in accordance with the manufacturer's instructions.
 - 8) Do not install near any heat sources such as radiators, heat registers, stoves, or other apparatus (including amplifiers) that produce heat.
 - 9) Do not defeat the safety purpose of the polarized or grounding-type plug. A polarized plug has two blades with one wider than the other. A grounding type plug has two blades and a third grounding prong. The wide blade or the third prong are provided for your safety. If the provided plug does not fit into your outlet, consult an electrician for replacement of the obsolete outlet.
 - 10) Protect the power cord from being walked on or pinched particularly at plugs, convenience receptacles, and the point where they exit from the apparatus.
 - 11) Only use attachments/accessories specified by the manufacturer.
 - 12) Use only with the cart, stand, tripod, bracket, or table specified by the manufacturer, or sold with the apparatus. When a cart is used, use caution when moving the cart/apparatus combination to avoid injury from tip-over.
- 
- 13) Unplug this apparatus during lightning storms or when unused for long periods of time.
 - 14) Refer all servicing to qualified service personnel. Servicing is required when the apparatus has been damaged in any way, such as power-supply cord or plug is damaged, liquid has been spilled or objects have fallen into the apparatus, the apparatus has been exposed to rain or moisture, does not operate normally, or has been dropped.

P1-4-2-2_En

IMPORTANT NOTICE –

THE SERIAL NUMBER FOR THIS EQUIPMENT IS LOCATED IN THE REAR. PLEASE WRITE THIS SERIAL NUMBER ON YOUR ENCLOSED WARRANTY CARD AND KEEP IN A SECURE AREA. THIS IS FOR YOUR SECURITY.

D1-4-2-6-1_En

WARNING: Handling the cord on this product or cords associated with accessories sold with the product will expose you to chemicals listed on proposition 65 known to the State of California and other governmental entities to cause cancer and birth defect or other reproductive harm.

Wash hands after handling

D36-P4-A_En

Congratulations on your purchase of a Pioneer KURO flat panel television.

KURO is the future of Pioneer flat-panel displays. It's a world without boundaries. A place where the senses evolve, colors are felt and sounds can be tasted. An experience that changes not only the way you look at television, but the way you look at the world.

We are proud to incorporate this philosophy of exceptional quality, state-of-the-art design and meticulous engineering to make the KURO undeniably unique and bring you one of the best entertainment experiences possible.

Please take some time to read through this owner's guide and manual to learn about the many features and benefits that set the KURO apart. We hope you enjoy the experience of owning the KURO and invite you to enter a new world of seeing and hearing like never before.

TABLE OF CONTENTS

- 1 Introduction to the 20FD Series Flat Panel TVs 6**
 - 1.1 Flat Panel TV Shipment Checklist 6
 - 1.2 Control Options: Get to Know Your Flat Panel TV 8
 - 1.2.1 Control Buttons and More on the Flat Panel TV..... 8
 - 1.2.2 Operating the Remote Control..... 10
 - 1.2.3 Buttons on the Remote Control 12
- 2 Install Your Flat Panel TV 14**
 - 2.1 Choose a Location and the Mounting Method..... 14
 - 2.1.1 Check the Location for Suitability..... 15
 - 2.1.2 Lift and/or Move Your Panel (the How To's)..... 15
 - 2.2 Install the Panel Using a Stand 16
 - 2.2.1 Use or Remove the Included Stand..... 16
 - 2.2.2 Connect the Speaker Cables..... 20
 - 2.3 Wall/Ceiling Mounting..... 22
 - 2.4 Mount the Flat Panel TV 24
 - 2.5 Connect to Broadcast TV & Other Devices (DVR, Receiver, BDR, etc.) 26
 - 2.5.1 Add Analog (conventional) and Digital TV Channels..... 26
 - 2.5.2 Connect Your Other Pioneer Equipment..... 26
 - 2.5.3 Connect the Power Cord to the Panel..... 29
 - 2.6 Route then Bundle the Power Cord and Cables 29
- 3 Basic Operations For Television Viewing 31**
 - 3.1 Turn the Flat Panel TV ON/OFF 31
 - 3.2 Program the Flat Panel TV for Television Viewing..... 32
 - 3.2.1 Choose Analog or Digital TV Channels 32
 - 3.2.2 Explore the Home Menu 32
 - 3.2.3 Assign a Language..... 34
 - 3.2.4 Set the Clock..... 35
 - 3.2.5 Create the List of Channels 35
 - 3.2.6 Skip or Delete Unwanted Channels..... 38
 - 3.2.7 Channel List..... 39
 - 3.3 Quick Start for Watching Television 41
 - 3.3.1 Change the Channel/Sub-Channel..... 41
 - 3.3.2 Adjust the Volume/Sound..... 41
 - 3.3.3 Turn On the Sleep Timer..... 41
 - 3.4 Adjust the Picture and Sound Quality 42
 - 3.4.1 Adjust the Picture for Your Room Lighting 42
 - 3.4.2 General Picture (Video) Adjustment for an AV Source 43
 - 3.4.3 Compare Images When Adjusting the Picture..... 44
 - 3.4.4 Display a Graphical Picture/Sound Adjustment Screen..... 45
 - 3.4.5 Sound Control..... 46
 - 3.4.6 General Sound (Audio) Adjustment..... 46

TABLE OF CONTENTS

3.5	Block Programs, Channels, or Content.....	47
3.5.1	Assign a Parental Control (Block) Password.....	47
3.5.2	Activate Parental Control.....	48
3.5.3	Assign a Rating System to Create Blocks.....	48
3.5.4	Temporarily Remove a Block.....	51
3.6	Smart Starts for New Owners.....	52
3.6.1	Use the TOOLS Menu.....	52
3.6.2	Extend Your Panel Life.....	52
3.6.3	Turn On the Image Orbiter.....	53
3.6.4	Trigger the Screen-Saving Video Pattern Periodically.....	53
3.6.5	Activate Energy Save to Reduce Power Usage.....	53
4	Additional Picture and Sound Adjustment Options	54
4.1	Choose an AV Option (Video, Game, etc.).....	54
4.1.1	AV Source through the Remote Control.....	54
4.1.2	Choose an AV Source through the Home Menu.....	55
4.1.3	Choose a PC Source.....	55
4.1.4	Set the Panel to Recognize a Game Console.....	56
4.2	Adjust Specific Picture Elements.....	56
4.2.1	Choose a Screen Size (Automatically or Manually).....	56
4.2.2	Correct the Picture for an AV or PC Source.....	58
4.3	Assign Advanced Picture Functions.....	59
4.3.1	Adjust for Screen Masking (black bars on sides).....	59
4.3.2	Select a PureCinema Level for High Quality Image.....	60
4.4	View in Multi-Screen.....	61
4.4.1	Split/Swap/Shift the Screen.....	61
4.5	Freeze the Picture.....	62
4.6	Use the Banner Feature.....	63
4.7	Select Alternatives for/to Sound.....	64
4.7.1	Activate Closed Captioning (CC).....	64
4.7.2	Switch Languages Using MTS.....	66
4.7.3	Select SAP.....	66
4.7.4	Apply Sound Effect Settings.....	67
4.7.5	Use Auto Volume Control (AVC).....	67
4.8	Manage the Power.....	67
5	Use Other Equipment With Your Flat Panel TV	69
5.1	Program the Remote Control to Operate Other Equipment.....	69
5.1.1	Assign a Manufacturing Code to the Remote Control.....	69
5.1.2	Issue a Library Search for a Manufacturer Code.....	69
5.1.3	Clear Added Manufacturer Codes from the Remote Control.....	70
5.1.4	Control a Pioneer Receiver.....	70
5.1.5	Control a Cable (CBL) or Satellite (SAT) System.....	71
5.1.6	Control a Video Cassette Recorder (VCR).....	72
5.1.7	Control a DVD Player/DVR Recorder/BD Player.....	73
5.2	Use HDMI Inputs.....	74
5.2.1	Specify the HDMI Input Type.....	74
5.2.2	Specify a Digital HDMI Signal Type.....	75
5.2.3	Specify an Audio HDMI Signal Type.....	75
5.3	Control Equipment with the Panel's Remote Through HDMI.....	76
5.3.1	Control an AV System.....	78
5.3.2	Control a Recorder.....	79
5.3.3	Control a Player.....	79
5.3.4	Add an AV Amp or a BD Player.....	80
5.4	Specific HDMI Control Commands.....	81
5.4.1	Play Source Sound Using an HDMI Command.....	81
5.4.2	Turn OFF the Power With an HDMI Command.....	81
5.4.3	Turn ON the Power With an HDMI Command.....	81
5.4.4	Test the Power Control (On/Off).....	82

5.5	Connect a Game Console or Camcorder	82
5.6	Operate the Home Media Gallery	83
5.6.1	<i>Network Connections</i>	84
5.6.2	<i>Connect a USB Device</i>	86
5.7	Run the Home Media Gallery.....	88
5.7.1	<i>Show Your Movie Files on the Flat Panel TV</i>	91
5.7.2	<i>Play Your Music Files on the Flat Panel TV</i>	93
5.7.3	<i>Show Your Photo File on the Flat Panel TV</i>	94
5.8	Use the TOOLS Menu	96
5.9	HMG Setup	108
5.10	Other useful functions.....	109
5.11	Add Other Audio Equipment.....	111
5.12	Add a Computer (PC)	112
5.12.1	<i>Automatic Image Position and Clock Adjustments</i>	112
5.12.2	<i>Manual Image Position and Clock Adjustments</i>	112
6	Helpful Information	113
6.1	Frequently Asked Questions (FAQs)	113
6.2	Check Your Software/Hardware Version	114
6.3	Cleaning Methods.....	114
6.4	Troubleshooting & Service Information.....	115
6.4.1	<i>Check the Signal Strength</i>	120
7	Cautions and Warnings.....	121
7.1	Installation Details	121
7.2	Physical Location & Temperature Considerations	121
7.3	Usage Guidelines.....	121
7.4	Signal Interference or Noise	122
7.5	Phosphor Properties.....	122
7.6	Image Information Including Retention & After-Image Lag	122
7.7	Safety Precautions.....	124
7.8	Legal Notices.....	124
7.8.1	<i>Safety</i>	124
7.8.2	<i>Radio Interference</i>	125
8	Appendix	126
8.1	Ratings Charts (for Various Audience Classifications)	126
8.1.1	<i>TV Ratings (age-based)</i>	126
8.1.2	<i>U.S. TV Parental Guideline Ratings (age/category-based)</i>	126
8.1.3	<i>MPAA Movie Ratings (age-based)</i>	126
8.1.4	<i>Canadian - English Ratings (age-based)</i>	127
8.1.5	<i>Canadian - French Ratings (age-based)</i>	127
8.2	Manufacturer Codes to Program into the Remote Control.....	128
8.2.1	<i>Cable</i>	128
8.2.2	<i>Satellite</i>	128
8.2.3	<i>VCR (Brands A - F)</i>	129
8.2.4	<i>VCR (Brands G - O)</i>	130
8.2.5	<i>VCR (Brands P - V)</i>	131
8.2.6	<i>VCR (Brands W - Z)</i>	131
8.2.7	<i>PVR</i>	132
8.2.8	<i>BD (HD-DVD)</i>	132
8.2.9	<i>DVD-R</i>	132
8.2.10	<i>DVD (Brands A - N)</i>	133
8.2.11	<i>DVD (Brands O - Z)</i>	134
8.2.12	<i>LD</i>	134
8.3	Specifications.....	135
8.4	Glossary	152
8.5	Index.....	154
8.6	Trademarks, Licenses, & Patent Information	155

1 Introduction to the 20FD Series Flat Panel TVs



The Pioneer 20FD Series Flat Panel TV models include the 60-inch **PDP-6020FD** and the 50-inch **PDP-5020FD** (screen sizes measured diagonally). Below is a list of all accessories shipped with your panel. If an item is missing, please contact your dealer or our Service organization immediately. Service contact information is listed on the back of this manual.

1.1 Flat Panel TV Shipment Checklist

In addition to the flat panel TV, there are several accessories included to make installation quick and easy. Please check for contents before discarding or allowing your installer to discard any packing material. The PDP-6020FD and PDP-5020FD shipments have slightly different pieces. Identify the accessories from the appropriate list below.

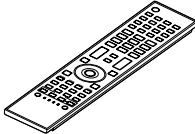
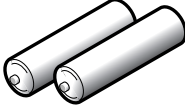

You will need a Philips screwdriver when mounting the speaker and attaching the stand.

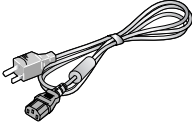
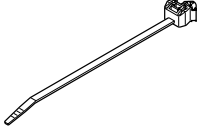
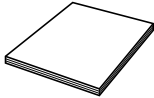
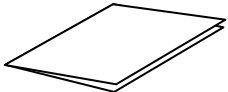
Shipped with both models

<input type="checkbox"/> Remote Control	<input type="checkbox"/> Batteries for Remote (2)	<input type="checkbox"/> Cleaning Cloth
		
<input type="checkbox"/> Power Cord (2 m/6.6 feet)	<input type="checkbox"/> Cable Clamps (4)	<input type="checkbox"/> Operating Instructions
		
		<input type="checkbox"/> Warranty Card
		

Also shipped with the PDP-6020FD (60" panel)

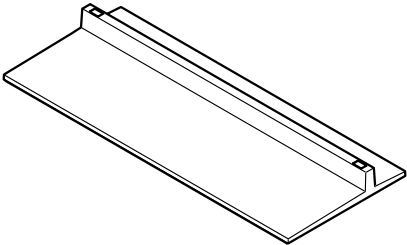
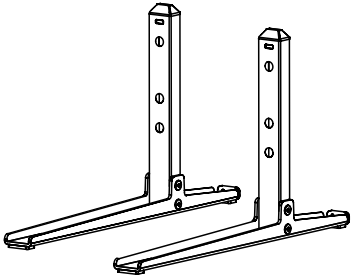
Stand kit

<input type="checkbox"/> Base Cover	<input type="checkbox"/> Stand Pipes (2)
	
<input type="checkbox"/> Silver Screws (4) (4×10 mm)	<input type="checkbox"/> Black Screws (4) (M6×20 mm)
	

Also shipped with the PDP-6020FD (60" panel)

- Falling Prevention Metal Fittings (2)

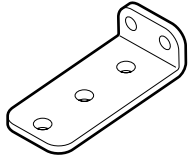

- Screws to Metal Fittings (4) (M4×35 mm)

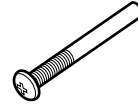

Speaker accessories

- Speaker Cables (2)

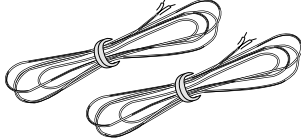

- Speaker

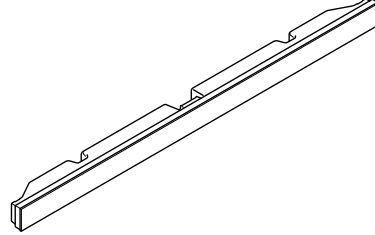

- Speaker Mounting Screws (9) (M5×10 mm)



- Speaker Bracket (Center)

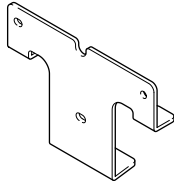

- Speaker Brackets (Left & Right)

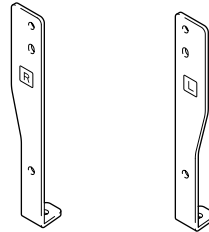

Also shipped with the PDP-5020FD (50" panel)

Stand kit

- Falling Prevention Metal Fittings (2)

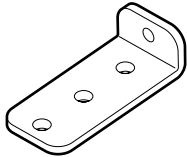

- Screws to Metal Fittings (2) (M4×35 mm)

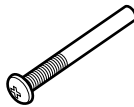

Speaker accessories

- Speaker Cables (2)

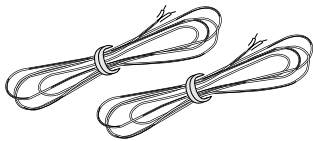

- Speaker Brackets (Side) (2)

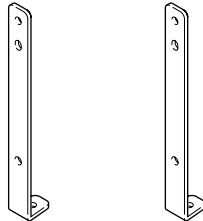

- Speaker

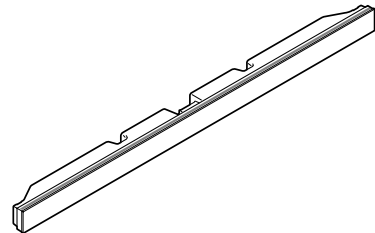

- Speaker Mounting Screws (9) (M5×10 mm)



- Speaker Bracket (Center)

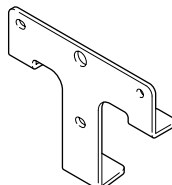

1.2 Control Options: Get to Know Your Flat Panel TV

You can operate your flat panel TV from the panel buttons or with the remote control. The following sections provide button locations/operations for the panel and the remote control.

1.2.1 Control Buttons and More on the Flat Panel TV

Your flat panel TV has buttons, indicators, and sensors on the lower front bezel with more buttons, toggles, and ports on the panel sides. Refer to the drawings below for specific locations and functions. Or, for the back ports and terminals only, check the terminal position sheet located near the panel's terminal compartment to identify the various options.

20FD Series Models: Face of Panel

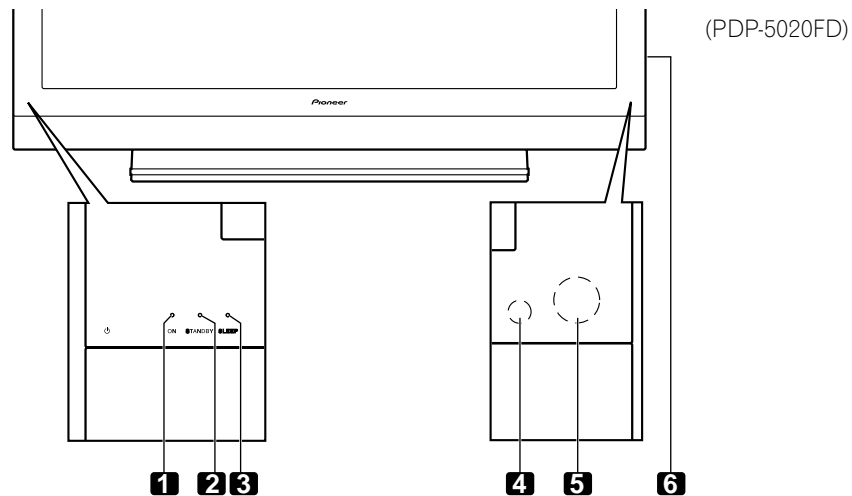

- 1 -Power ON indicator
- 2 -STANDBY indicator
- 3 -SLEEP indicator

- 4 -Room Light sensor
- 5 -Remote Control sensor
- 6 -Bezel (some call it the front frame)

Command Side of the Panel (left side)

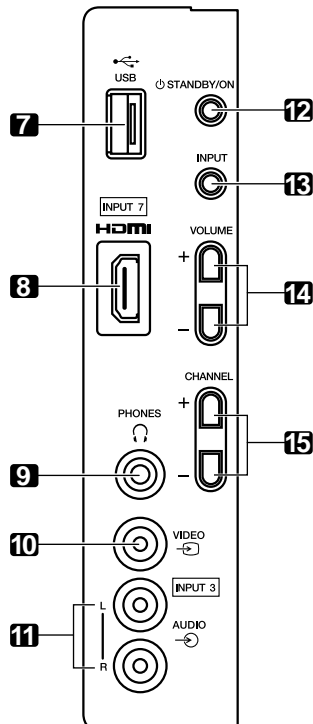

- 7 -USB terminal
- 8 -INPUT 7 terminal (HDMI)
- 9 -PHONES terminal
- 10 -INPUT 3 terminal (Video)
- 11 -INPUT 3 terminals (Audio)
- 12 -STANDBY/ON button
- 13 -INPUT button
- 14 -VOLUME Up/Down buttons
- 15 -CHANNEL Up/Down buttons

Back of the Panel

- 1 -ANT terminal
- 2 -PC Input terminal (Analog RGB)
- 3 -AC In terminal (upper bank)

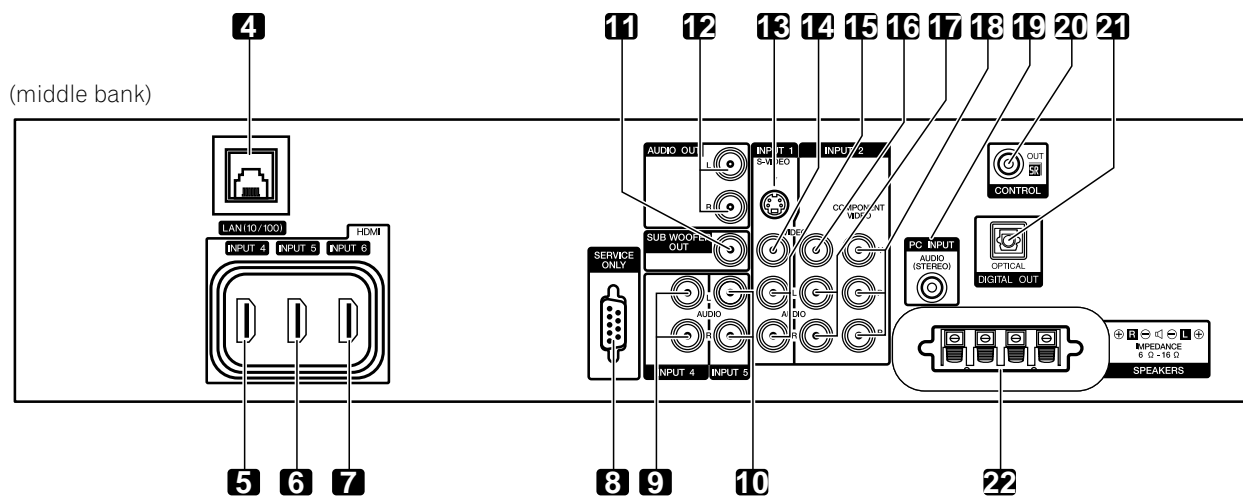
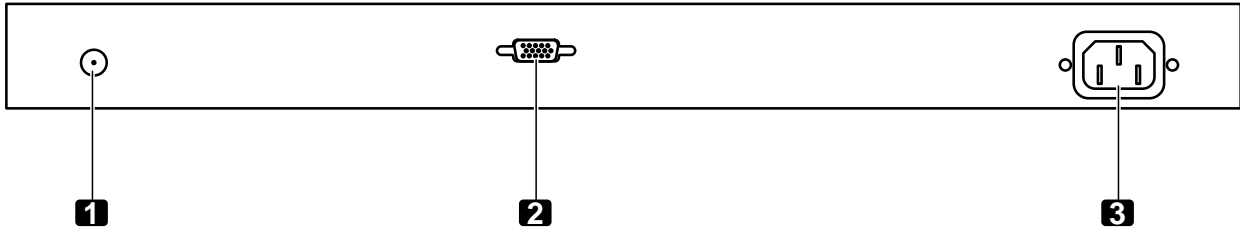

- 4 -Ethernet cable port
- 5 -INPUT 4 terminal (HDMI)
- 6 -INPUT 5 terminal (HDMI)
- 7 -INPUT 6 terminal (HDMI)
- 8 -RC-232C terminal (for factory use)
- 9 -INPUT 4 terminals (Audio)
- 10 -INPUT 5 terminals (Audio)
- 11 -SUB WOOFER OUT terminal
- 12 -AUDIO OUT terminals (Audio)
- 13 -INPUT 1 terminal (S-Video)
- 14 -INPUT 1 terminal (Video)
- 15 -INPUT 1 terminals (Audio)
- 16 -INPUT 2 terminal (Video)
- 17 -INPUT 2 terminals (Audio)
- 18 -INPUT 2 terminals (Component, Y, P_B, P_R)
- 19 -PC INPUT terminal (Audio)
- 20 -CONTROL OUT terminal
- 21 -DIGITAL OUT terminal (Optical)
- 22 -SPEAKERS (right/left) terminal

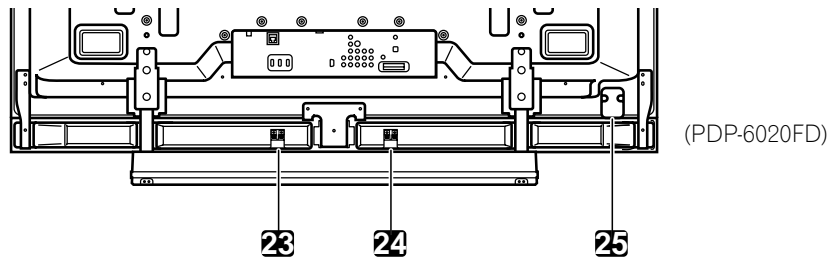

- (lower bank)
- 23 -Speakers (R) terminal (speaker side)
 - 24 -Speakers (L) terminal (speaker side)

25 -Power On button

Terminals on side and rear panels are common to both 20FD models.

1.2.2 Operating the Remote Control

The remote control for the 20FD Series panels is a powerful tool. This section provides a brief introduction to your remote control while later sections explore more advanced operations.

Insert the Batteries into the Remote Control

To open push and slide the battery cover in the direction of the arrows. Load the supplied two AA size batteries by the negative polarity (–) ends first.

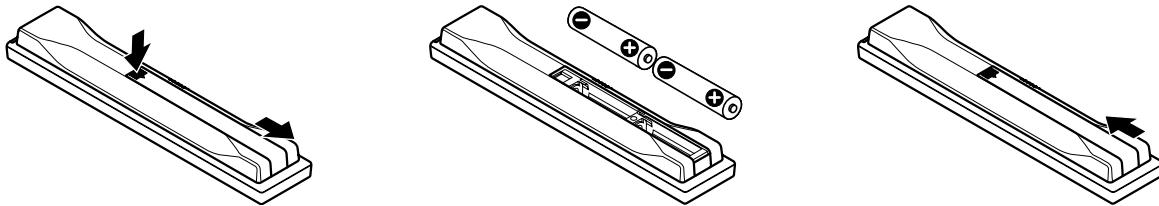

The batteries supplied with this product may have a shorter life expectancy due to storage conditions. If the remote control seems to be failing or is weak, replace the provided batteries with new alkaline batteries.

Never mix old and new batteries. Mixing old and new batteries can shorten the life of new batteries or cause chemical leaks in old batteries. Also, mixing different types or brands of batteries can cause issues as batteries brands have slightly different characteristics.

Note: If the flat panel TV's remote control is not needed for an extended length of time, remove the batteries.

When disposing of used batteries, please comply with governmental regulations or environmental public institution's rules that apply in your country/area.

Remote Control Issues

There are several issues that can affect your remote control but the most common problem is weak batteries. Weak batteries in the remote control can cause communication to fail or only operate sporadically. In this situation, try moving closer to the panel and attempt to control the panel with the remote. If the panel responds then change the batteries. If moving closer has no effect on the panel, check the surroundings for objects that might be blocking the signal. Also consider other equipment with remote controls that are in the area around the panel. Objects and other IR signals can disrupt the remote. For more help with your remote control, refer to "6.1 Frequently Asked Questions (FAQs)".

Operating Range for the Remote Control

To control the flat panel TV, point the remote towards the sensor on the panel's bottom right corner. For easy operation, keep the distance between the remote control and the sensor less than 7m (23 feet) and at an angle of less than 30 degrees.

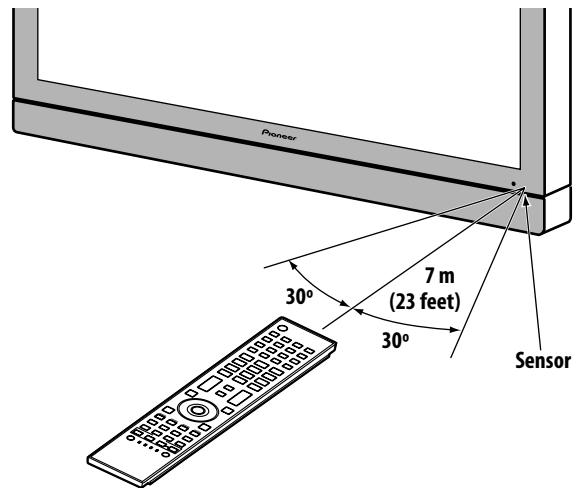

The remote control may not work properly if the sensor is in direct sunlight or very bright lighting. If your viewing room is naturally bright, change the position of the panel or physically use the remote control closer to the panel's sensor.

Note: If the remote control is left sitting in direct sunlight or under a very strong light, the case could warp or deform.

1.2.3 Buttons on the Remote Control

Except for a few options, commands available through the buttons on the flat panel TV are duplicated on the remote control. The remote control can be programmed to control other equipment such as a DVD Player, Surround Sound system, etc. A later section entitled "5 Use Other Equipment With Your Flat Panel TV" explains how to use the remote to control other equipment.

This section identifies and describes the buttons on the remote control.

Remote: Left side buttons (top to bottom, left to right)

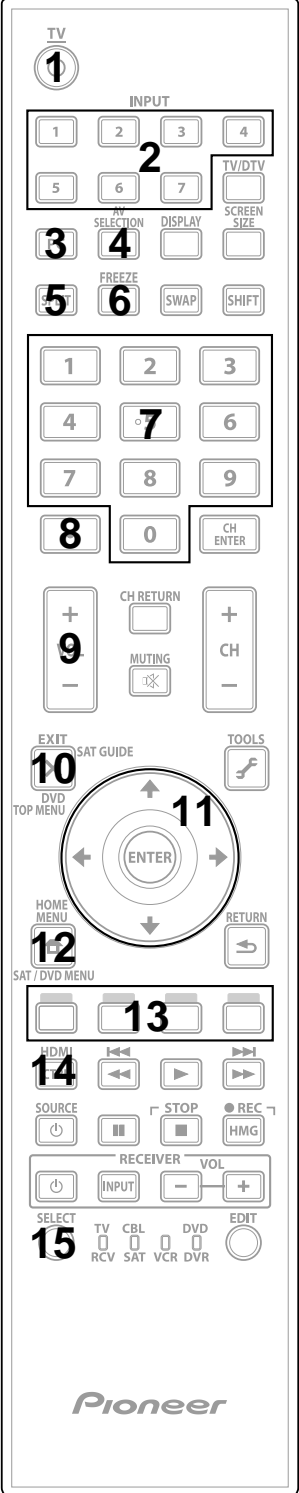
<p>TV : 1 Turn On or place panel in Standby</p> <p>INPUT: 2 Select a source (INPUT 1 thru INPUT 7)</p> <p>PC: 3 Select the PC terminal as an input source</p> <p>AV SELECTION: 4 Select audio/video settings AV Source: OPTIMUM, PERFORMANCE, DYNAMIC, MOVIE, GAME, SPORT, Standard PC Source: STANDARD, USER</p> <p>SPLIT: 5 Cycle view thru single-screen, 2-screen, picture-in-picture</p> <p>FREEZE: 6 Freeze a frame from a moving image then press again to cancel the freeze function</p> <p>Number buttons 0 thru 9: 7 Select a channel</p> <p>•(dot): 8 Enter a dot for selecting a sub-channel</p> <p>VOL +/-: 9 Set the volume</p> <p>EXIT: 10 Exit the menu to return to the normal screen</p> <p>Arrow buttons: 11 Navigate the menu screens</p> <p>HOME MENU: 12 Display the HOME MENU</p> <p>Color buttons (Red, Green, Blue, Yellow): 13 Control a BD player for HDMI Control functions only</p> <p>HDMI CONTROL: 14 Select the HDMI Control functions</p> <p>SELECT: 15 Select for TV/RCV, CBL/SAT, VCR, or DVD/DVR</p>	 <p>The diagram shows a Pioneer remote control with 15 numbered callouts: 1 points to the TV power button; 2 points to the INPUT buttons (1-7); 3 points to the PC button; 4 points to the AV SELECTION buttons; 5 points to the SPLIT button; 6 points to the FREEZE button; 7 points to the number buttons 0-9; 8 points to the dot button; 9 points to the volume +/- buttons; 10 points to the EXIT button; 11 points to the directional arrow buttons and the central ENTER button; 12 points to the HOME MENU button; 13 points to the color buttons (Red, Green, Blue, Yellow); 14 points to the HDMI CONTROL buttons; 15 points to the SELECT button.</p>
--	---

Remote: Right side buttons (top to bottom, left to right)

16 **TV/DTV:**
Select analog or digital TV channels

17 **DISPLAY:**
Display the channel information

18 **SCREEN SIZE:**
Select the screen size

19 **SWAP:**
Switch between the two screens when viewing as 2-screen or picture-in-picture

20 **SHIFT:**
Move the location of the small screen when viewing as picture-in-picture

21 **CH ENTER:**
Change the channel

22 **CH RETURN:**
Return to the previous channel

23 **MUTING:**
Turn off the sound while the video continues to play

24 **CH +/-:**
Cycle through channels

25 **TOOLS:**
Display the TOOLS Menu - refer to "3.6 Smart Starts for New Owners"

26 **ENTER:**
Execute a command

27 **RETURN:**
Return to the previous menu screen

28 **Player/Recorder Control:**
Use buttons for control of connected equipment

29 **HMG (Home Media Gallery):**
Display the Home Media Gallery menu
Use this button to start recording (for VCR/DVD recorder only)

2 Install Your Flat Panel TV

There are several installation options for your flat panel TV. This chapter walks you through how to choose an installation site, the best mounting methods, and how to install your panel.

2.1 Choose a Location and the Mounting Method

Your flat panel TV is very thin. The panel needs a solid surface and some sort of support structure (a stand, table, etc.) to protect it from being tipped over or knocked down. Use installation accessories and parts included with the shipment. Pioneer recommends working with a qualified installer whenever possible.

Regardless of the mounting method, anchor or secure your flat panel TV using a combination of the mounting holes and/or supplied bolts.

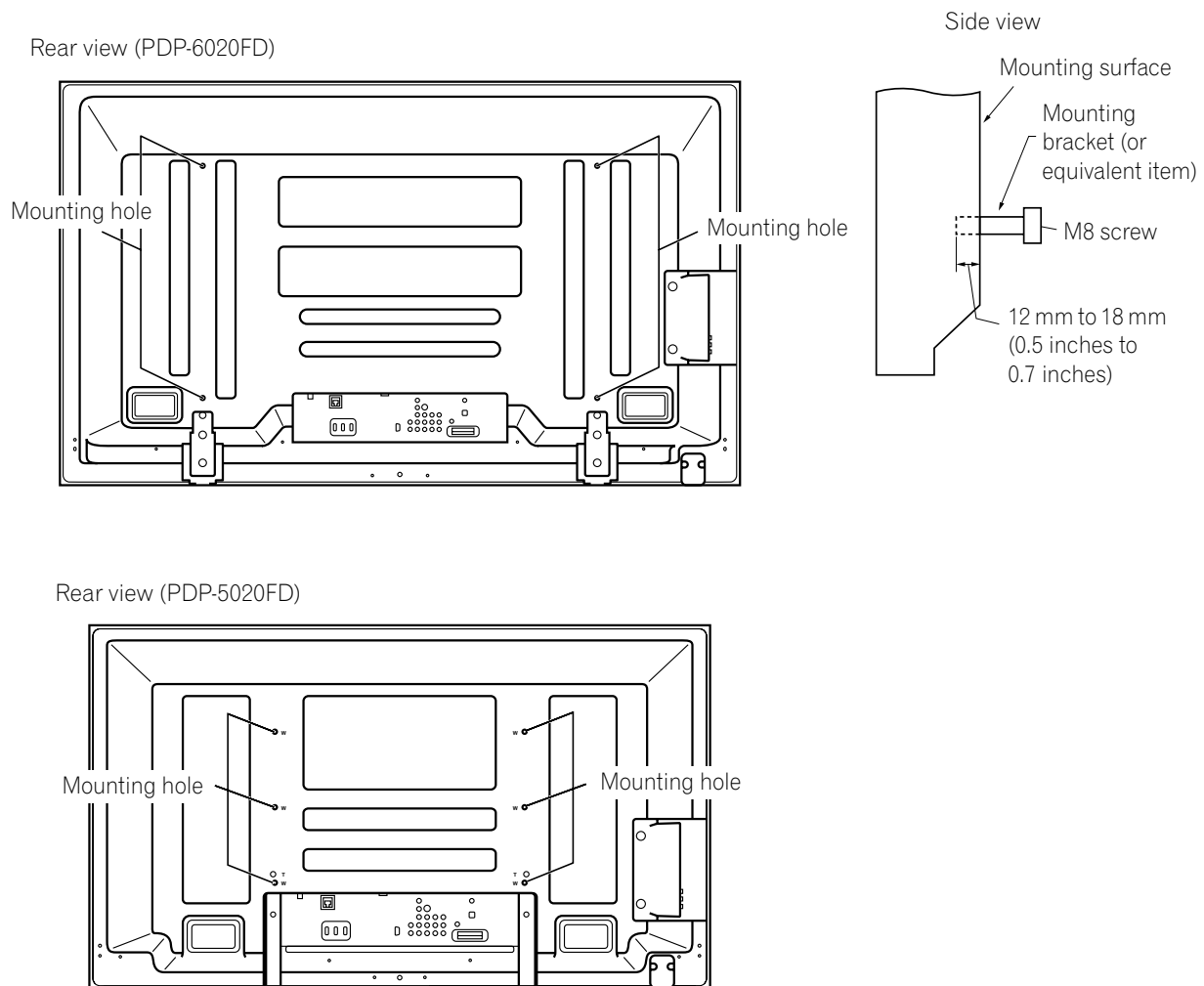

Note: Some installation options require a different type of bolt. Check with your installer or dealer to purchase the appropriate bolt(s).

2.1.1 Check the Location for Suitability

When choosing the location for your panel, there are several factors you need to keep in mind. The installation site should be out of direct sunlight and have sufficient ventilation around the flat panel TV to allow cooling. The diagram below is an example of a stand-mounted panel with proper ventilation.

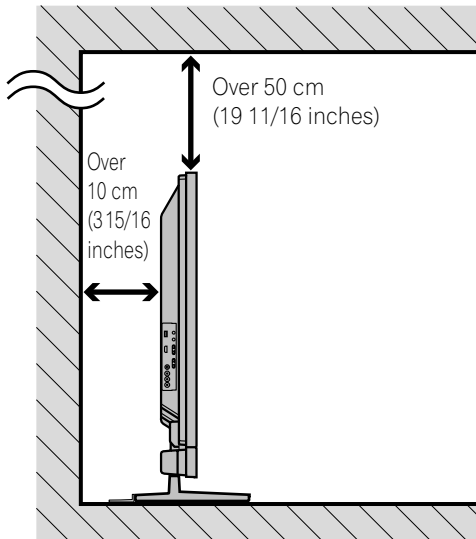

The distance behind and above the panel changes depending on your choice of mount. Consult with your dealer or professional installer for proper ventilation.

Use the checklist below to judge possible installation sites.

- | | |
|---|--|
| <input type="checkbox"/> Sufficient ventilation | <input type="checkbox"/> No danger of power overloads |
| <input type="checkbox"/> Safe from excessive vibrations | <input type="checkbox"/> Separate from other IR equipment |
| <input type="checkbox"/> Away from air conditioners | <input type="checkbox"/> Protected from hits or shocks |
| <input type="checkbox"/> Free of moisture or dampness | <input type="checkbox"/> Distance from heat sources |
| <input type="checkbox"/> No danger of splashing water | <input type="checkbox"/> Out of direct sunlight |
| <input type="checkbox"/> Route cords and cables safely | <input type="checkbox"/> Away from strong lighting sources |

For specific cautions and safety information, refer to “7.2 Physical Location & Temperature Considerations” and “7.7 Safety Precautions.”

2.1.2 Lift and/or Move Your Panel (the How To's)

This flat panel TV is built for endurance but because of the technology, the panel must be handled with care. Use the handles attached to the rear of the flat panel TV to lift the unit. To avoid flexing or twisting the unit, you need at least two people to lift and move the panel. Do not move the flat panel TV by holding only a single handle or by dragging the panel by its handles.

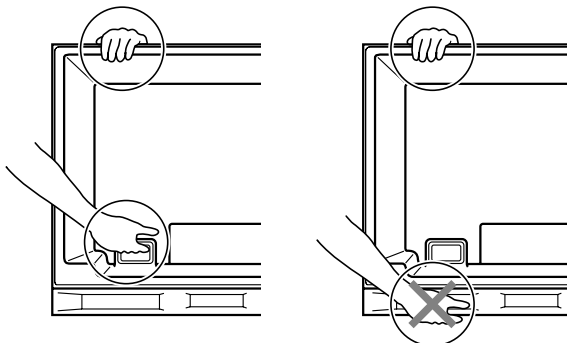

Use the handles to move the panel. Do not move the panel by holding the speaker or speaker brackets.

Note: Do not use the handles to hang the flat panel TV or as anchors to prevent the panel from slipping or tipping after it is mounted.

2.2 Install the Panel Using a Stand

2.2.1 Use or Remove the Included Stand

The PDP-5020FD ships with the Pioneer table top stand (stand) attached. Attach the included stand to the panel for the PDP-6020FD. For PDP-5020FD, attach the falling prevention metal fittings after placing the panel to stand upright.

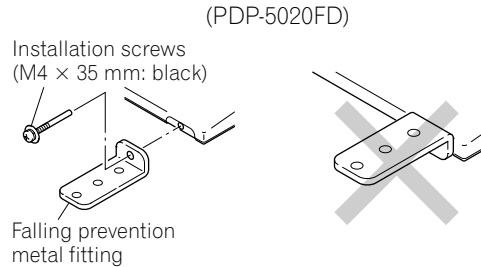

Attach the Stand to the Panel

Do not handle the flat panel TV on a wagon or pallet that is smaller than its stand. The stand will bend.

- 1) Detach the speaker if it has already been added.
Refer to "Attach/Detach the Speaker" on page 18 for assistance.
- 2) Lay the flat panel TV down on a raised surface with the stand base hanging over the edge.
- 3) Place all stand parts on a soft cloth to avoid scratching.
If you are mounting the PDP-6020FD continue with Steps 4 and 5. If you are mounting the PDP-5020FD skip to Step 7.
- 4) Turn the base cover over so that the bottom is facing up.
- 5) Insert the stand supports (legs) into the base cover.

Please carefully install the supports (left and right) so that they are in the correct positions. Misaligned supports can damage the base and/or the supports.

- 6) Tighten the base screws to lock the supports in to place.

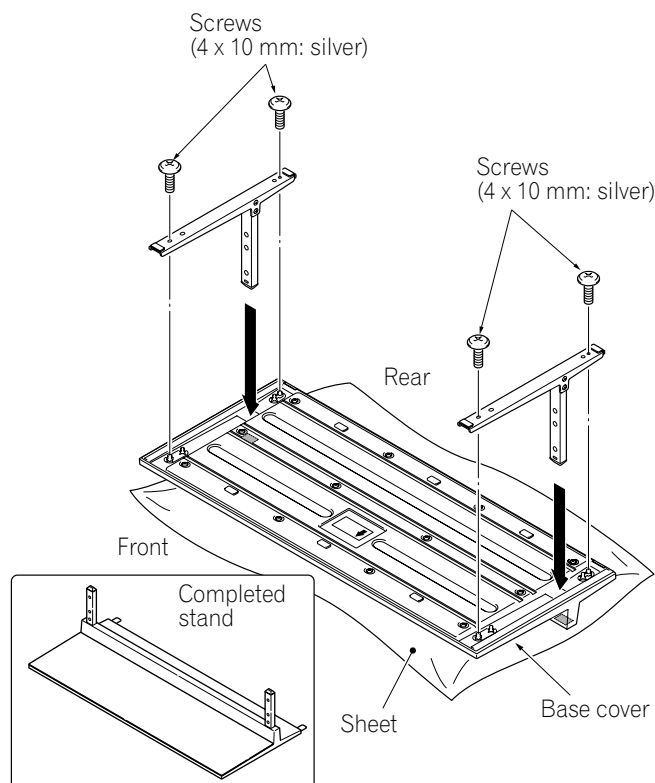

Note: Assemble the stand with a soft sheet placed under the base cover. If a sheet is not laid before assembly, the front surface of the base cover may be scratched.

7) After assembling the stand, attach the falling prevention metal fittings using the installation screws.

(PDP-6020FD)

Installation screws
(M4 x 35 mm: black)

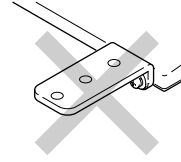
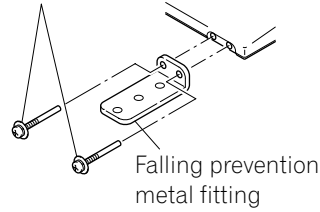

8) With the flat panel TV still face down, insert the stand's supports into the bottom of the panel then tighten the screws.

Line up the column supports with the bottom of the flat panel TV.

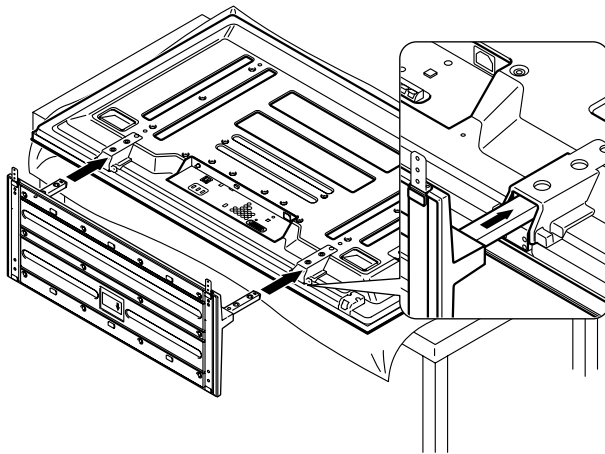

Installation bolts (M6 x 20 mm) Installation bolts (M6 x 20 mm)

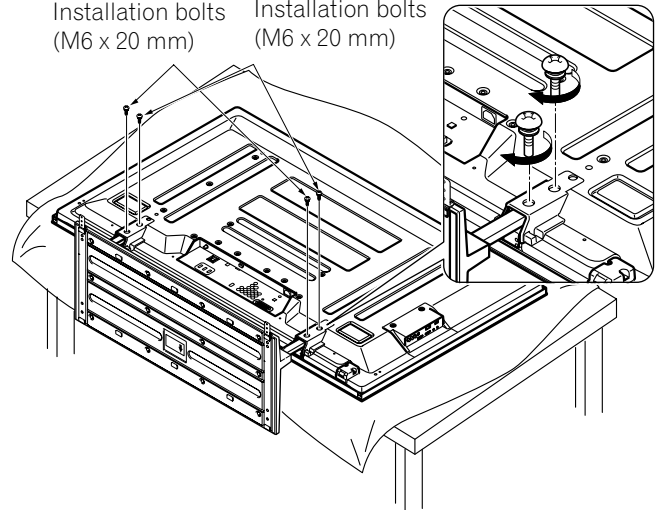

Insert the stand supports into the flat panel TV so that the arrow marked "FRONT/FACE AVANT" on the bottom of the stand points down.

9) With the assistance of at least one other person, lift the panel upright then move it in to position.

Attach/Detach the Speaker

The flat panel TV's speaker delivers high-quality, clear sound. The left/right balance is enclosed in a single unit for ease of installation and compactness. Although other devices can be added or removed from the mounted panel, physically attach the speaker last. Disconnect the cables from the Speaker and REMOVE THE SPEAKER before mounting or moving the panel.

Before attaching the speaker to your mounted panel, review the information below.

- Lay the panel face down on a stable surface when attaching speaker brackets.
- Use only the supplied screws and tighten securely before stepping away.
- The speaker is wide and requires more than a single person to manage.
- Handle the speaker carefully to protect the cabinet and grille net from scratches and other damage.
- Placing a CRT monitor near the speaker can cause a blur on the flat panel TV. Keep the distance between the speaker and the monitor.

- Connecting this speaker to another panel or device can damage the unit or cause a fire.
- When using tone control to increase treble, avoid over-amplifying the volume.

Note: Use the foam packing materials to protect the equipment from scratches or other damage during mounting.

Stand-Mounted Panel

It is possible to attach the speaker brackets to the flat panel TV while it is standing upright though it is easier to mount the brackets while the panel is laying flat. Once the brackets are attached, stand the panel upright then move it into the final position before mounting the speaker.

- 1) Attach the side speaker brackets (left and right) to the back of the panel using the supplied screws.

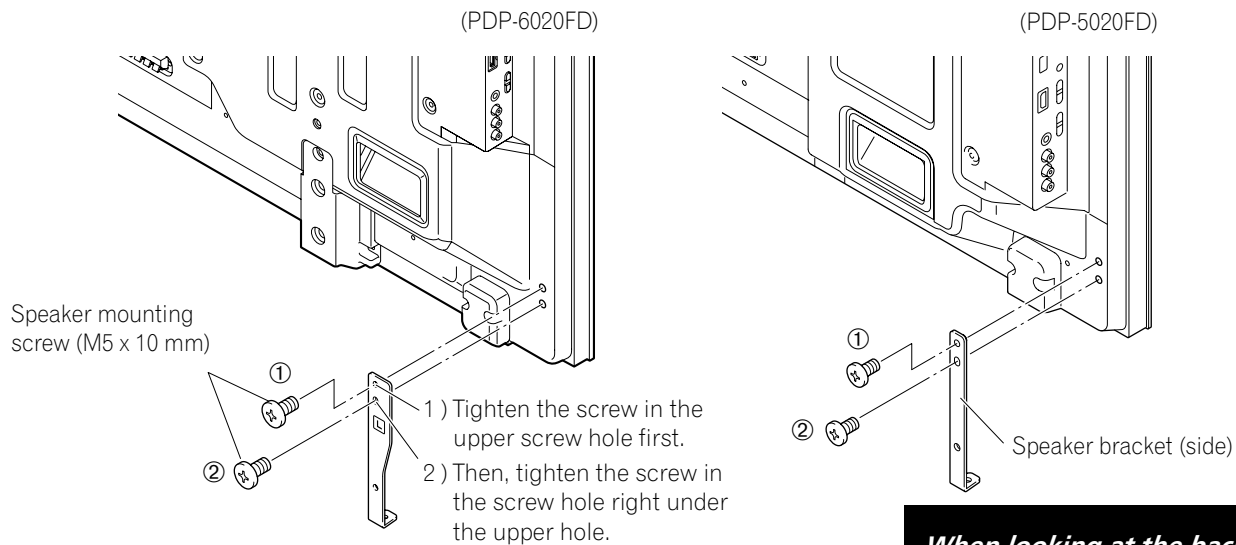

When looking at the back of the flat panel TV, sides are reversed. Tighten screws in the order shown above.

- 2) Attach the center speaker bracket using the supplied screws.
 When fitting the screws, place screws 1 and 2 through the holes in the center bracket.

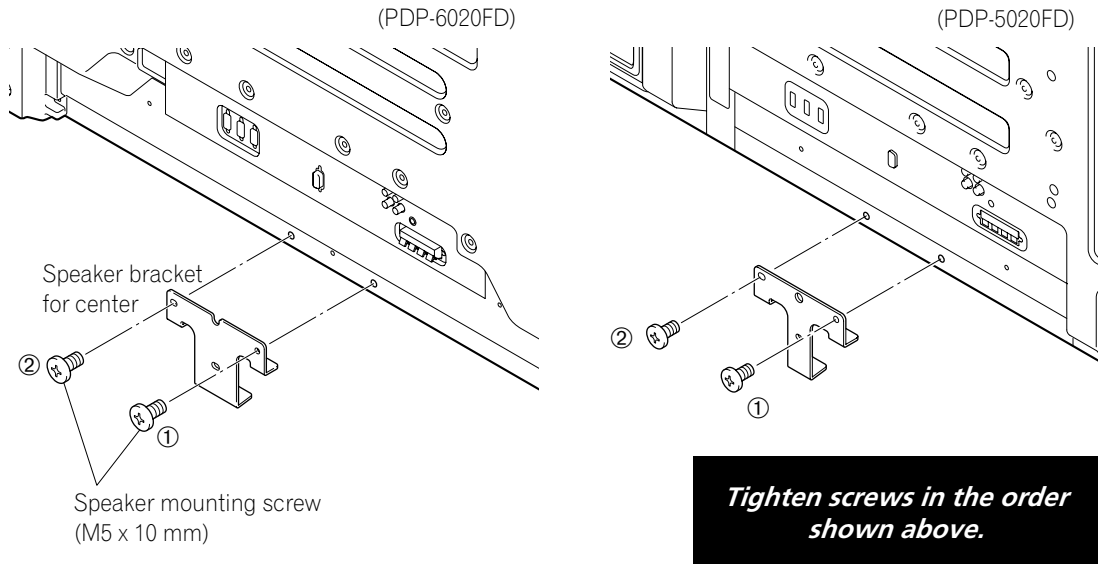

- 3) Position the speaker by the brackets.
 It is very easy to mount the speaker upside-down so confirm that the speaker is aligned properly before continuing.
- 4) Insert the speaker bracket into the grooves at the rear of the speaker.
 If the speaker fails to mount easily, adjust the angle of the brackets.

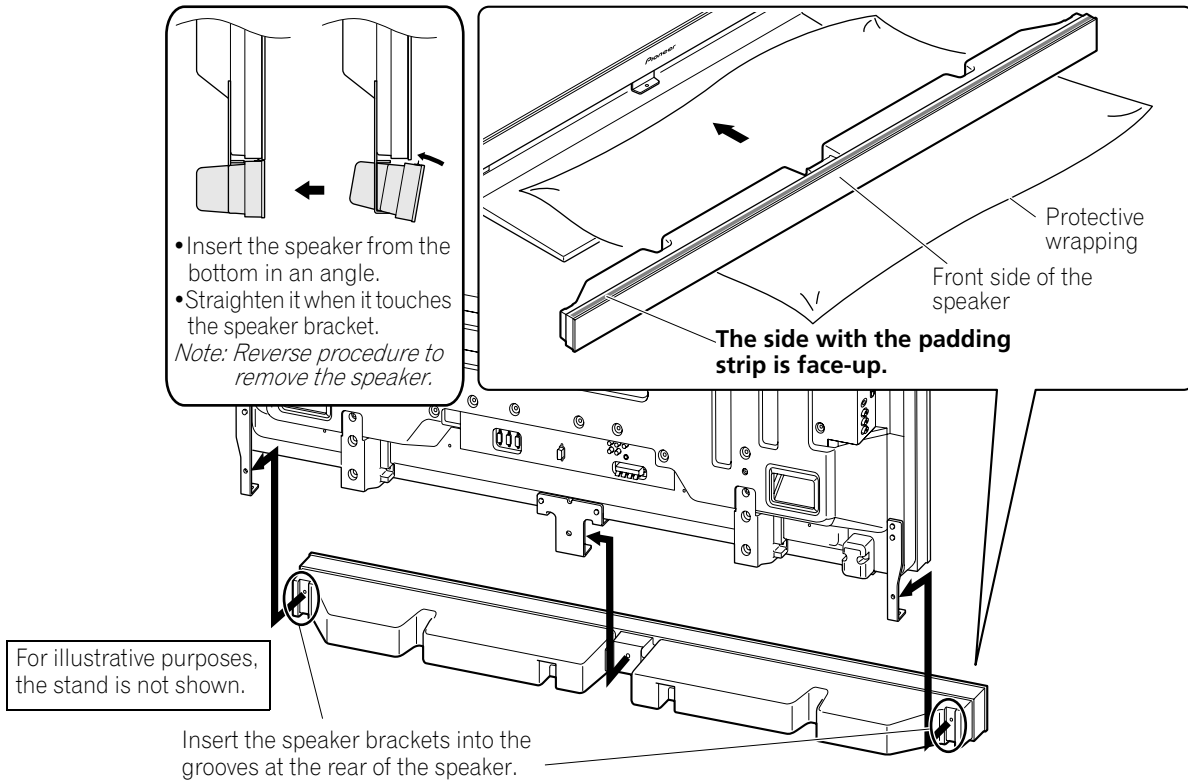

- 5) Attach the speaker to the center bracket using the supplied screws.
 The drawing in the next Step shows the proper order for tightening screws.

6) Attach the speaker to the side brackets using the supplied screws.

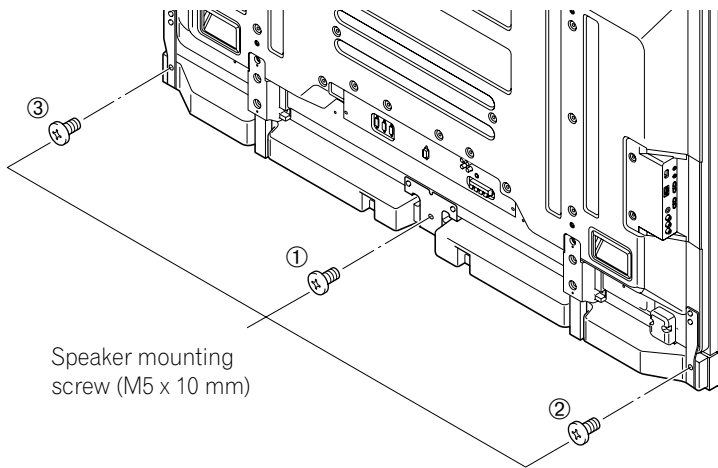

The bottom screw hole on each speaker bracket is not used when the panel remains on the stand.

Note: If the speaker needs to be repositioned (horizontally or vertically) after it is attached, loosen the speaker mounting screws first. Adjust the position then retighten the screws.

2.2.2 Connect the Speaker Cables

- 1) Press down on the tab.
- 2) Insert the appropriately colored wire into the opening.
- 3) Allow a small percentage of the cable's bare wire to remain visible.
- 4) Release the tab to clamp the wire.
If the bare wire is hidden when the tab is released, repeat Steps 1 through 4 until the proper amount of cable is showing.
- 5) Repeat this process for each cable, matching the color of the wire to the appropriate terminal.
- 6) Connect the speaker cables to the speaker.
- 7) Bundle the speaker cables, power cord and other cables in the cable clamp then insert the clamp into an appropriate hole on the rear of the flat panel TV.

*Refer to "2.6 Route then Bundle the Power Cord and Cables."
Use the clamps as necessary (see page 30).*

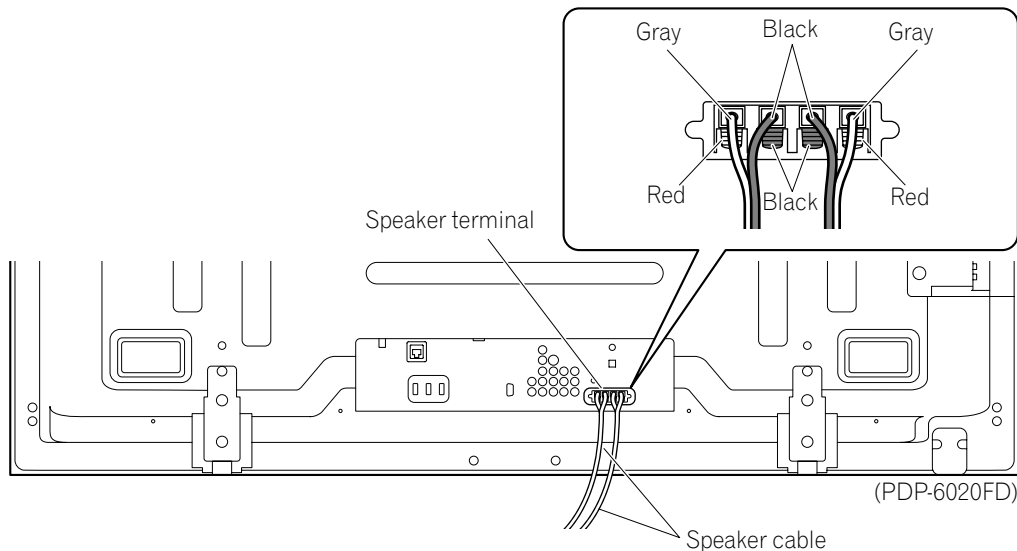
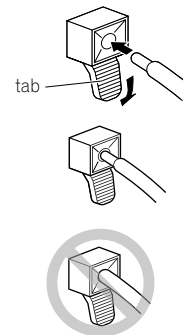

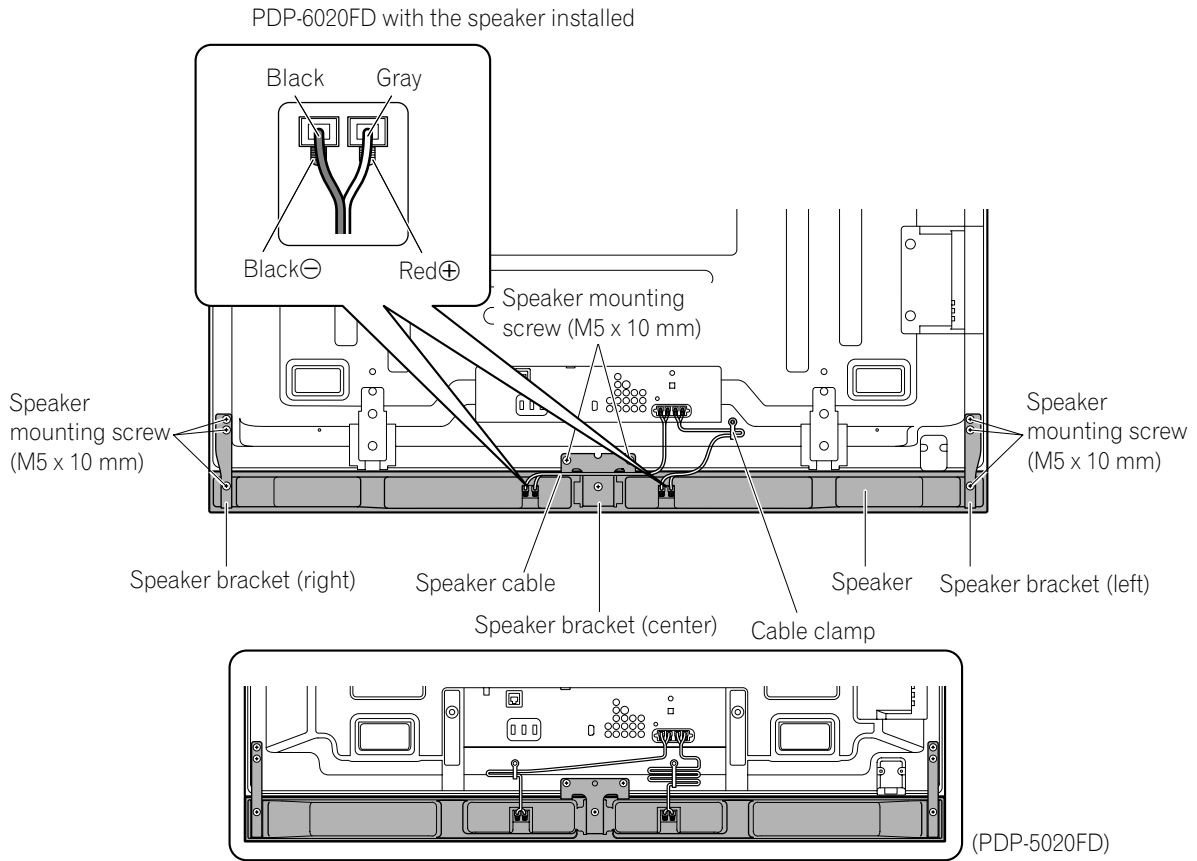

- Before connecting the speaker to the flat panel TV, unplug the panel from the power outlet. Connecting the speaker cable with the power cord plugged in can cause malfunction or damage to the panel if the cable's bare wire touches other equipment. Plug in the power cord after connecting the speaker.
- Do not leave speaker cable wires bare and exposed at the terminals. Exposed wires can result in an electrical short causing malfunction or damage to the system.
- Do not connect any devices to the speaker terminals other than the speakers specified.

2.3 Wall/Ceiling Mounting

Lay the 50" panel down on a raised surface then remove the stand.

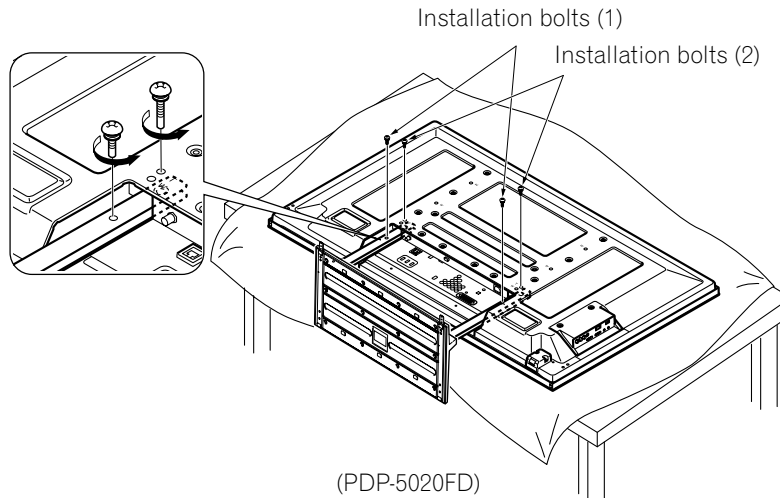

A common flat panel TV mounting option is to hang the panel on a sturdy wall or from a reinforced ceiling. When mounting in this way, some preparations must be completed first. Follow the steps below to prepare the panel for mounting.

- 1) Attach the speaker brackets but not the Speaker.
Refer to "Attach/Detach the Speaker" for instructions.
- 2) Connect the speaker cables to the panel if they are not already attached.
Connect the cables ONLY to the panel, not to the speaker.

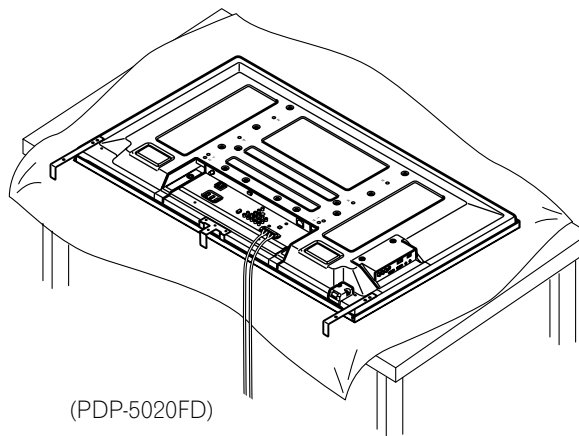

- 3) Connect cables for any other devices to the panel.
When deciding on a location for your flat panel TV, consider other equipment in the room. Equipment such as a DVR, Receiver, VCR, etc. requires some way to communicate with the panel, either directly or through another device. Review the instructions that came with the other equipment for available ports and terminals.
After deciding which ports and terminals are needed, mark the connections on the flat panel TV for easier identification once the panel is mounted.
- 4) Temporarily bundle loose cables with rubber bands (not included).
- 5) Plug the flat panel TV's power cord in to the panel but do NOT plug in to the power outlet.
- 6) Follow installation directions provided with your selected wall/ceiling mount.

Note: When attaching the speaker, refer to diagram in the following section regarding specific screw holes to use for wall or ceiling mounting.

Once your flat panel TV is mounted on the wall or suspended from the ceiling, follow the steps below to attach the speaker.

- 1) Confirm that the speaker brackets are ready to support the speaker.
It is possible to jar the brackets out of alignment while installing the panel.
- 2) Connect the loose ends of the speaker cables to the speaker.
If the cables were bundled with rubber bands during installation, remove them before continuing.
- 3) Align the speaker with the brackets.
It is very easy to mount the speaker upside-down so confirm that the speaker is aligned properly before continuing.
- 4) Insert the speaker brackets into the grooves at the rear of the speaker.
If the speaker fails to attach easily, adjust the angle of the brackets

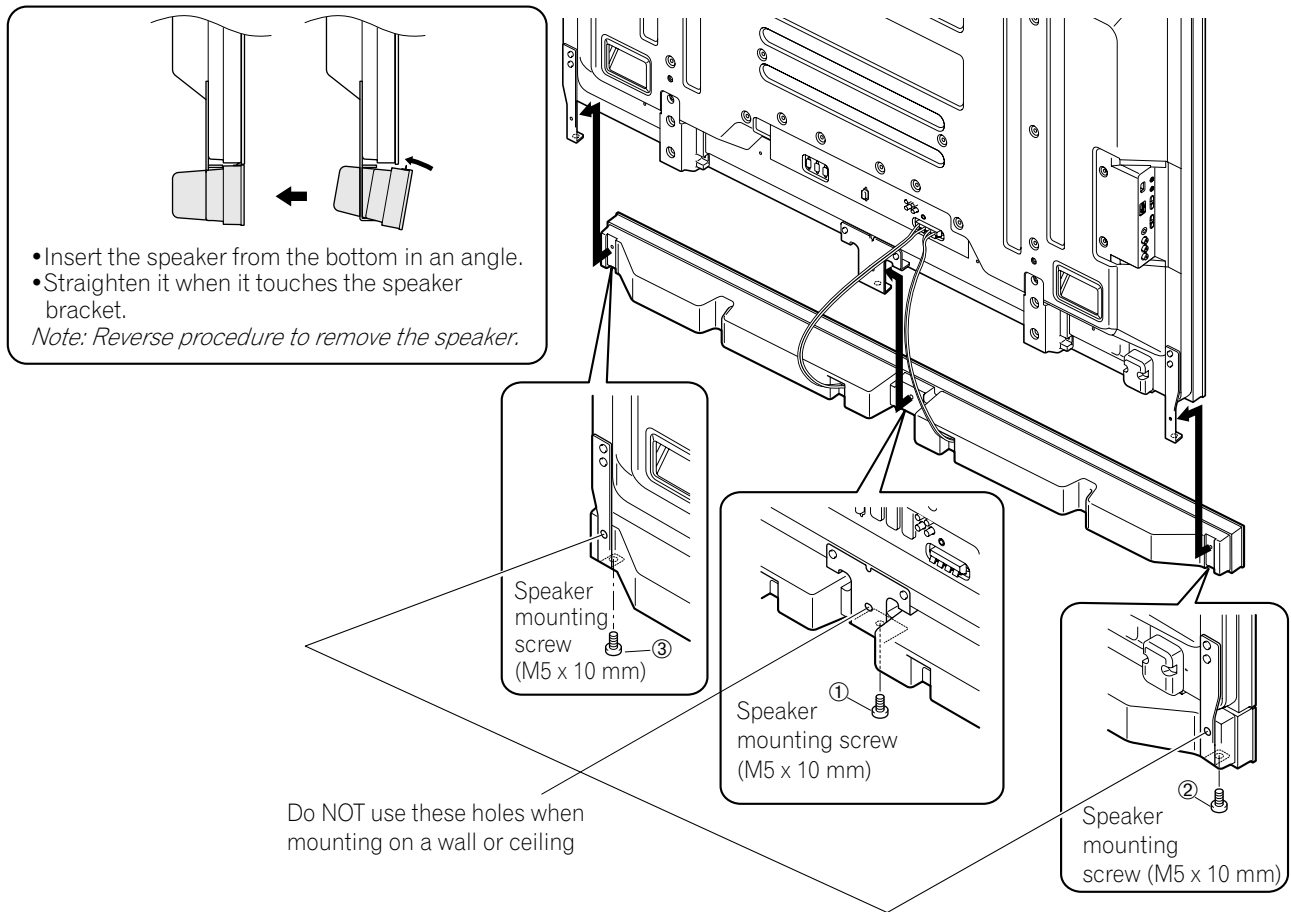

- 5) Tighten the center screw then the side screws in the order shown above.
When installing the panel on a wall or ceiling, use the bottom screw holes on each speaker bracket.

Note: If the speaker needs to be repositioned (horizontally) after it is attached, loosen the speaker mounting screws first. Adjust the position then retighten the screws.

2.4 Mount the Flat Panel TV

Because your flat panel TV is slim but heavy, have at least two people mount and/or position the panel. The following sections provide instructions for the different mounting and anchoring options.

Anchor the Panel When Using a Stand

When using a stand, stabilize the panel to keep it from tipping over. Please use the supplied metal fittings and screws to anchor the panel to a wall or other solid support structure.

Another option is to purchase hooks, cords, and fittings through your installer or from your local hardware store. The hardware size and strength depends on the composition and thickness of the anchoring surface.

Recommended hook: Nominal diameter 8 mm (3/8 inch), length 12 mm to 18 mm (0.5 inches to 0.7 inches)

To anchor the panel when using the provided stand, follow the steps below.

- 1) Attach the hooks to the mounting holes on the back of the panel.
- 2) Sink the fittings into the wall or support structure.
- 3) Run cords between the hooks and the fittings.
- 4) Tighten the cords until the panel is anchored but not pulled off balance.

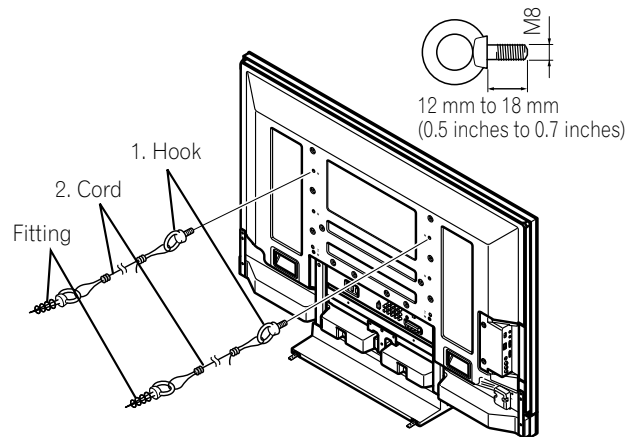

To stabilize the flat panel TV on a table or platform, use the supplied metal fittings and screws as well as commercially available wood screws. The wood screws are to anchor the metal fittings when mounting on a wooden surface. These screws should have a nominal diameter of 4 mm (5/32 inch) and are at least 20 mm (13/16 inch) long.

Notes: Avoid moving the table after the panel is attached.

Do not use bare wires for the cord. If any part of the wire is introduced into the ventilation port on the back of the display panel, fire or electrical shock could result.

Follow the steps below to secure your flat panel TV.

- 1) Mark locations for metal fittings and screws on the back edge of the table using the panel stand to determine placement.

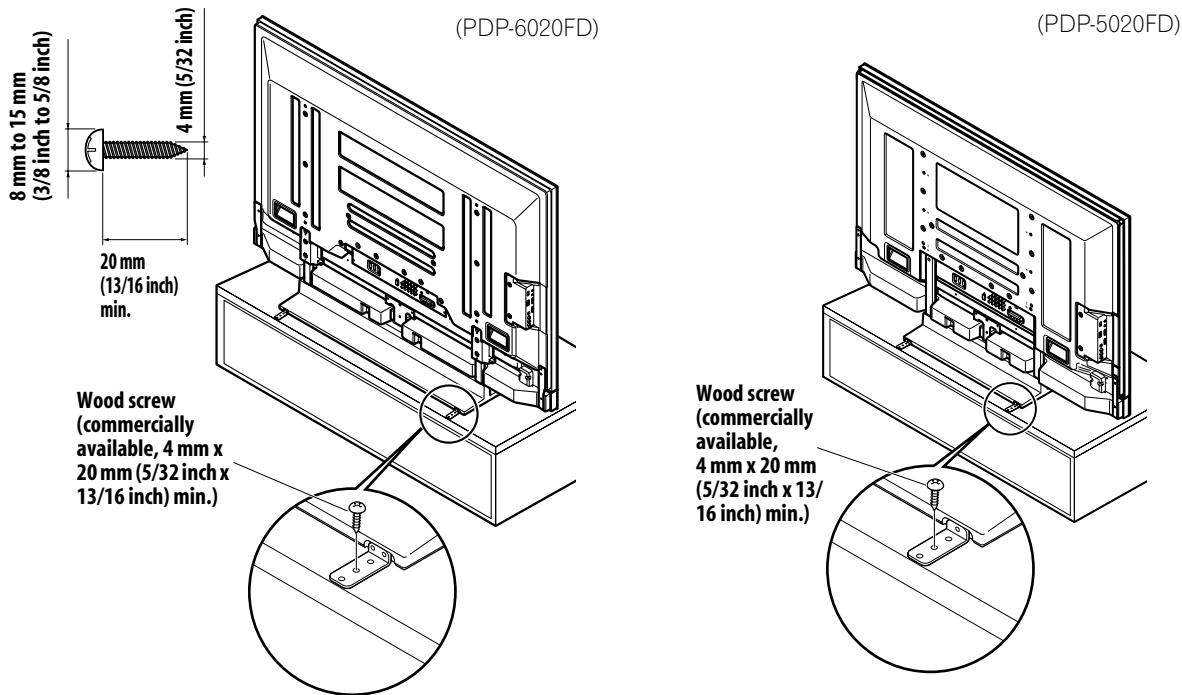

- 2) Drill holes in the table or platform edge at the marked locations.
- 3) Lift panel into place with the assistance with at least one other person.
- 4) Use wood screws (not included) to secure the metal fittings to the table.

2.5 Connect to Broadcast TV & Other Devices (DVR, Receiver, BDR, etc.)

The type of equipment attached to your flat panel TV determines which panel ports are used. The following sections explain how to connect broadcast TV and playback equipment such as a DVD player, Surround Sound system, video recorder, etc. to the panel. If your equipment is not listed, please refer to the operating instructions that came with the device(s) for connection assistance.

2.5.1 Add Analog (conventional) and Digital TV Channels

Whether a TV station broadcasts in Analog or Digital, your flat panel TV shows the programs as long as the panel is programmed to accept the signal. To program your panel for broadcast TV, select terminal ANT.

The ANT terminal accepts both analog and digital broadcasts. Connect a VHF/UHF antenna and/or cable TV to the panel's rear ANT terminal, then press **TV/DTV** on the remote control to toggle between analog and digital broadcasts. When watching analog TV channels, you can also use an outdoor antenna for the clearest analog picture.

If your outdoor antenna uses a 75-ohm coaxial cable with an F-type connector, plug it into the panel's antenna terminal on the back.

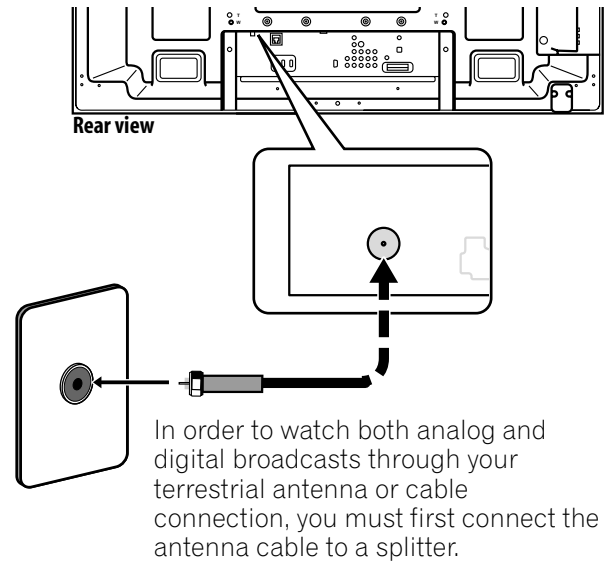

2.5.2 Connect Your Other Pioneer Equipment

This section provides cabling information for your other Pioneer equipment when combined with the panel. Each diagram can also be used as a reference tool for non-Pioneer devices but port locations may differ or be unavailable.

Connect cable or Satellite using STB (Set Top Box):

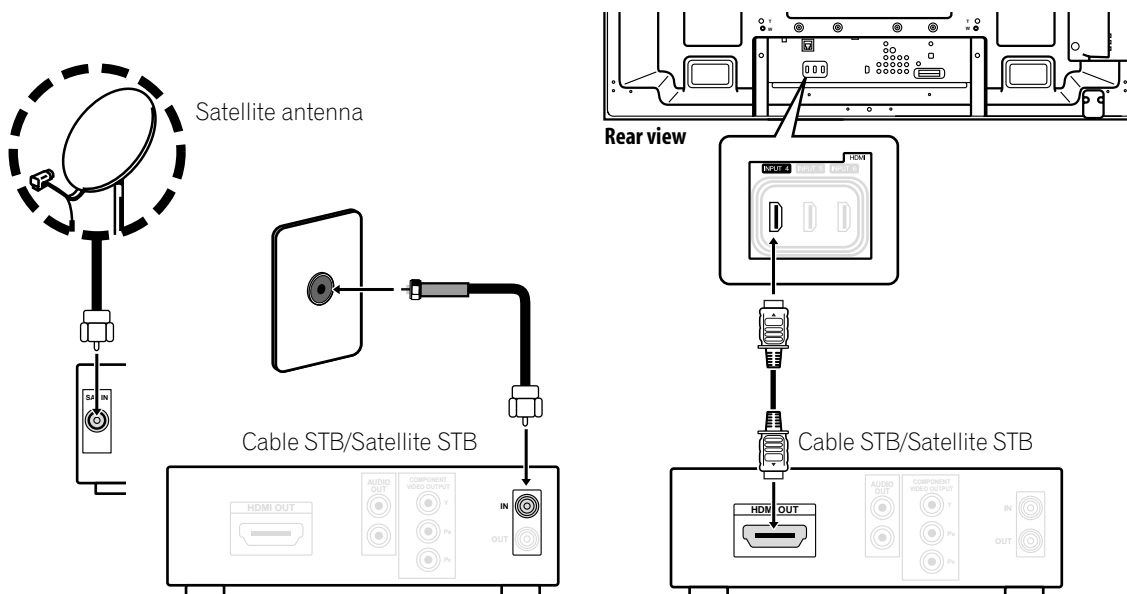

When using a cable STB or Satellite STB, plug in to the antenna/cable TV wall outlet using the STB cable provided with your STB. If your STB has an HDMI terminal, use any of INPUT 4 through INPUT 6 (HDMI terminal) on the rear or INPUT 7 (HDMI terminal) on the side of the flat panel TV instead of making video connections. If you connect an antenna cable directly to TV, you must first connect the cable to a splitter. For details, refer to the operating manual that came with the STB.

Connect HDMI equipment (INPUT 4 through INPUT 6):

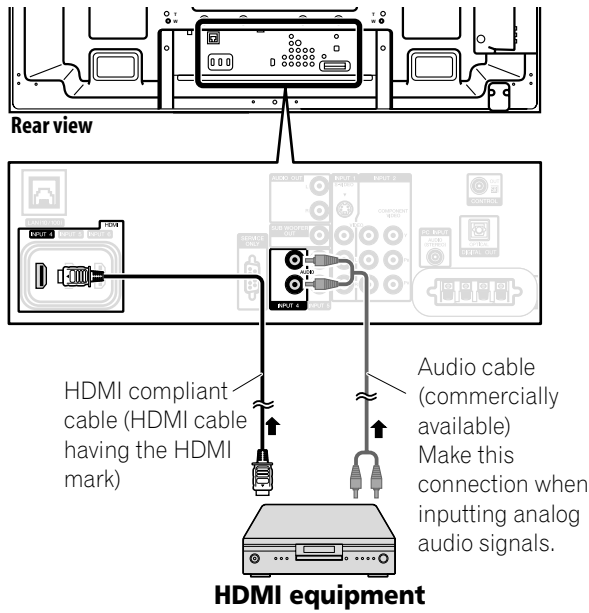

INPUT 4 through INPUT 6 are HDMI terminals. Use INPUT 4 or INPUT 5 (HDMI) terminal when you also input analog audio signals. For details, refer to "5.2 Use HDMI Inputs."

Connect HDMI equipment (INPUT 7):

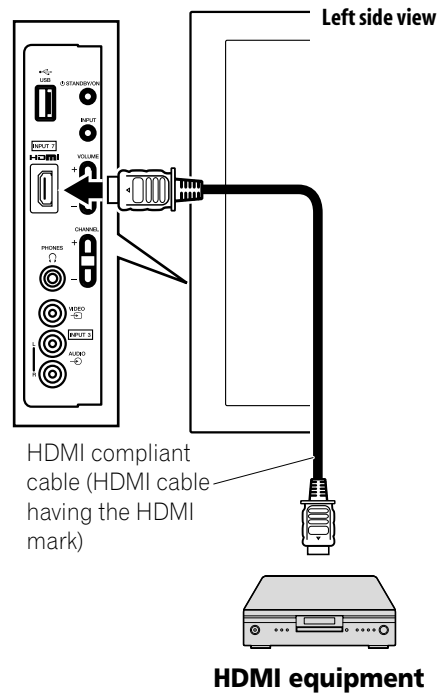

Also use INPUT 7 (HDMI terminal) on the side of the panel when connecting HDMI equipment. For details, refer to "5.2 Use HDMI Inputs."

Connect a DVD player:

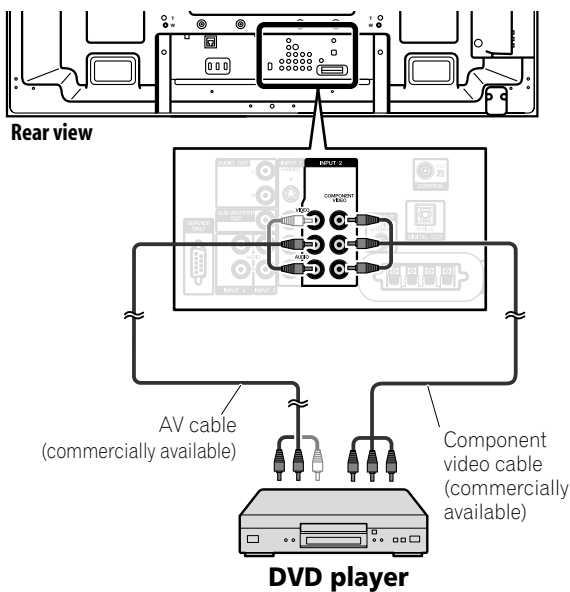

Use INPUT 2 terminals when connecting a DVD player or other audiovisual equipment. If your DVD player has an HDMI terminal, use this connection instead of making video connections. For details, refer to the operation manual that came with the DVD player.

Connect an AV receiver:

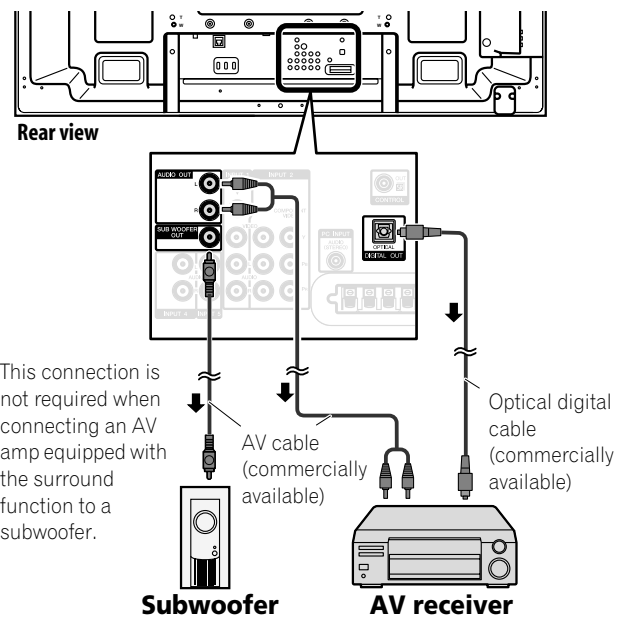

Use an optical digital cable to connect an AV receiver to DIGITAL OUT terminal (optical). If your AV receiver does not have a DIGITAL IN terminal (optical), you may connect the panel's AUDIO OUT terminal (audio) to the audio input terminal on the AV receiver. For details, refer to the operation manual that came with the AV receiver.

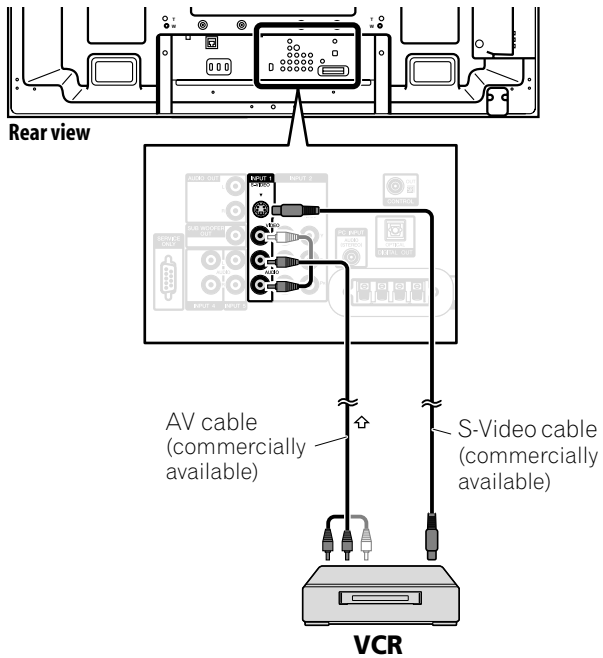
Connect a VCR:

Use INPUT 1 terminals when connecting a VCR or other equipment. For details, refer to the operation manual that came with the VCR.

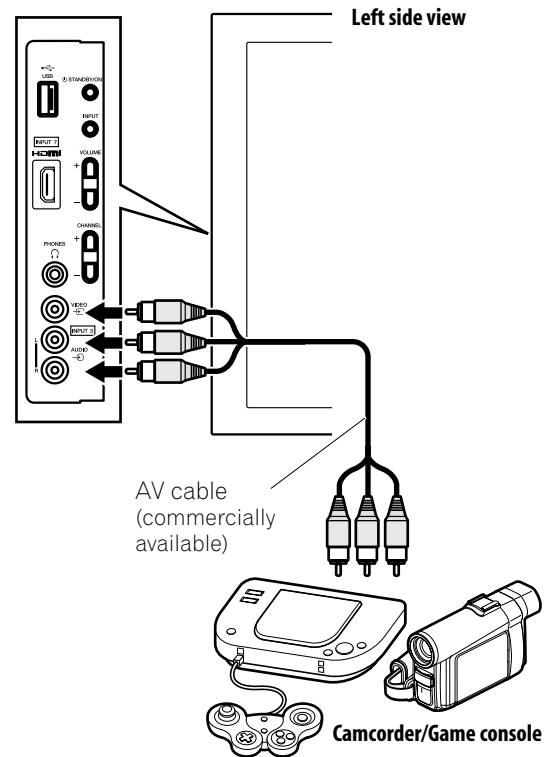
Connect a game console or camcorder:

Use INPUT 3 terminals when connecting a game console, camcorder or other audiovisual equipment. For details, refer to the operation manual that came with the game console or camcorder.

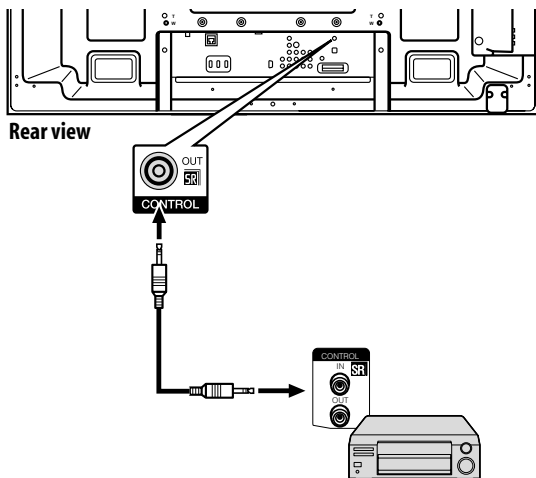
Connect control cords:

Connect control cords between the panel's CONTROL (OUT) terminal and other Pioneer equipment having the **SR** logo. Use a mono sound cable with a mini plug (not provided).

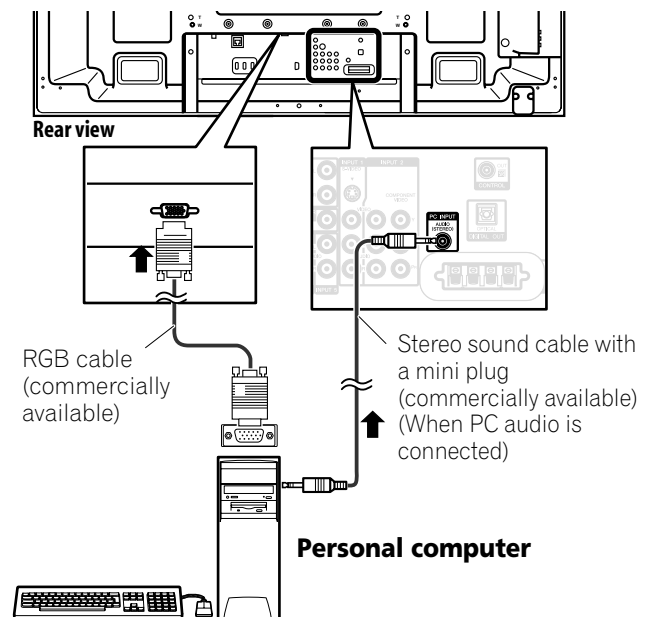
Connect a PC:

Use the PC INPUT terminal (Analog RGB) when connecting a PC. If you also connect PC audio, use PC INPUT (Audio) with a stereo sound cable with a mini plug (not provided). For details, refer to the operation manual that came with the PC.

2.5.3 Connect the Power Cord to the Panel

The final connection is the power cord. Always connect the panel's power cord to a three-pronged outlet, verifying that the cord is properly grounded. The cord includes a noise filter that reduces electrical interference from the wall outlet.

As long as the flat panel TV is plugged in to an outlet, some power is drawn through the panel. When the flat panel TV is not going to be used for a long period, unplug the panel from the power outlet. Unplugging the panel extends the life of the plasma as well as saves energy.

Plug the cord in to the panel but do NOT plug it in to a power outlet yet.

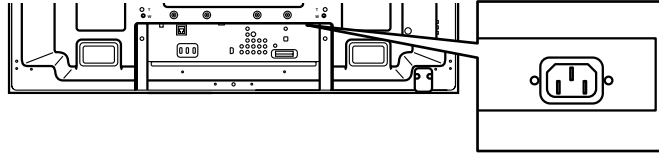

2.6 Route then Bundle the Power Cord and Cables

Once the flat panel TV is mounted and the speaker is attached, place additional equipment in the final position(s). Lay out the power cord, panel cables and any other device cables in a logical pattern that works for the location. Please consider the following points when routing cables:

- Access to a 3-prong (grounded) power outlet
- Space for the noise filter between the panel and outlet
- Placement of cables under carpets or across walking paths

Usually the cord/cables have slack or are too long. Although rubber bands are a good temporary solution to bundle cables, they tend to break down too quickly. To keep cables organized and neat, use the included cable clamps to bundle cables. The diagram below shows a bundled speaker cable.

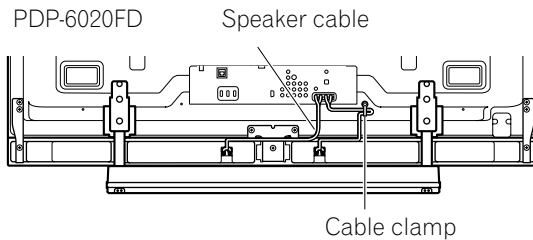

Bundle cables in small groups when possible for easier separation later, if necessary.

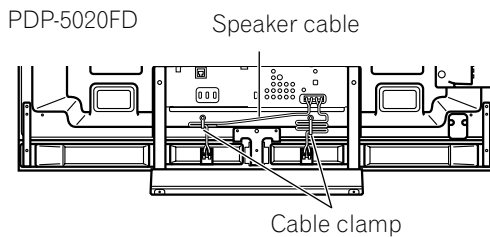

A reusable cable clamp is designed to lock the bundled cables in place. Your flat panel TV has a total of four holes to attach cable clamps to the back of the panel. Use the cable clamps as necessary.

PDP-6020FD

PDP-5020FD

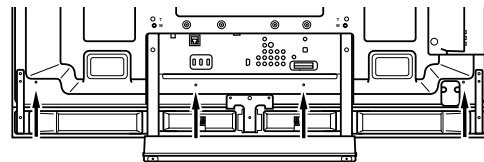
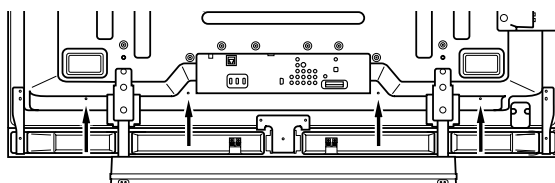

Follow the steps below to attach a cable clamp.

- 1) Thread the clamp band through the holder and bundle the cable(s) in the cable clamp.
- 2) Push and hold the levers then insert the hook into an appropriate hole on the rear of the flat panel TV.
- 3) Pull up the clamp band to lock.

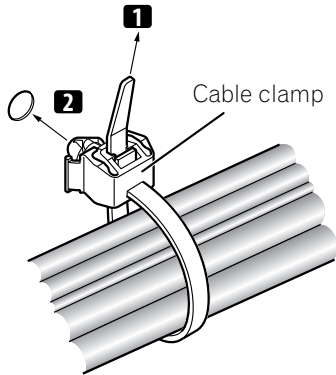

- 4) Confirm that the cable clamp is seated firmly in the panel.

Note: Avoid pinching or creating pressure points when routing or bundling cables.

To remove the clamp band, pull and hold the latch to release.

To remove the cable clamp, push and hold the levers then pull it out from the hole.

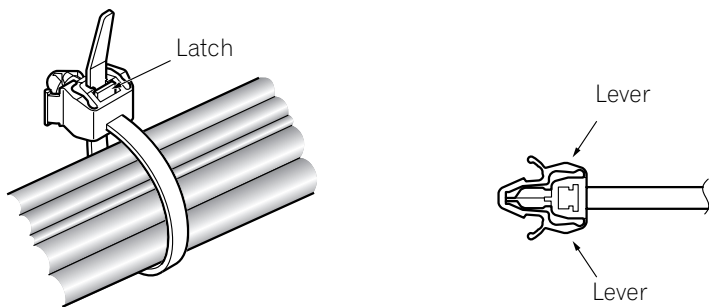

Note: The longer a clamp is in place, the better chance of deterioration. An older clamp is more easily damaged while being removed and may not be reusable.

3 Basic Operations For Television Viewing

This chapter explores day-to-day operations such as powering on your flat panel TV, using the Home Menu, and adjusting the panel for the viewing area/room. The final section in this chapter provides hints and suggestions for those new to flat panel TV features.

3.1 Turn the Flat Panel TV ON/OFF

Your flat panel TV has three activity levels: Power On, Standby, and Power Off. Standby saves energy but allows the remote control to turn on the panel.

The following instructions use the remote control. To operate the flat panel TV through the side panel buttons, refer to "1.2.1 Control Buttons and More on the Flat Panel TV" for button locations.

Turn ON the Flat Panel TV

To turn on the panel, follow the steps below.

- 1) Plug the flat panel TV's power cord in to a properly grounded outlet.
- 2) Press any of the following buttons to turn the flat panel TV On.
 - Power On button (⏻) on the panel's back lower-left section (see page 9)
 - **STANDBY/ON** button on the side of the panel (see page 8)
 - Remote control's **TV** (⏻) button located in the upper left corner (see page 12).
Images appear on the panel screen.

*Note: Use the remote control's **MUTING** button to reduce any excessive static noise.*

- 3) Confirm that the Power On indicator lights blue.

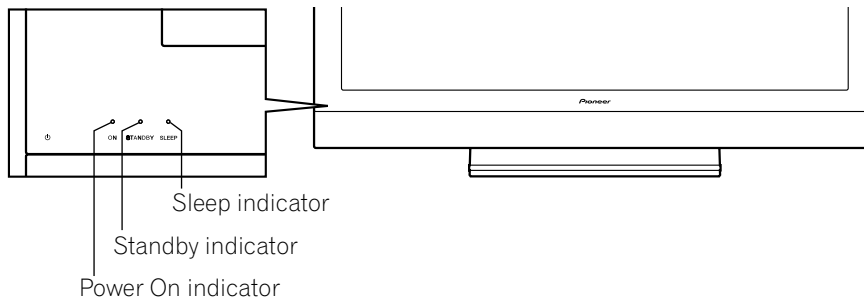

*Note: While in Standby, pressing the remote control's **TV** (⏻) button causes the flat panel TV to turn On.*

Turn OFF the Flat Panel TV

Turning off the flat panel TV can mean entering Standby so features such as Sleep are still functional or it can mean cutting power to the panel. Unless the flat panel TV is to sit idle for long periods, leave the panel in Standby.

Note: While in Standby or when powered off, the flat panel TV continues to draw some power as long as the panel is plugged in to an outlet.

Follow the steps below to place the panel in Standby.

- 1) Press the remote control's **TV** (⏻) button or panel's **STANDBY/ON** button.
- 2) Confirm that the Standby indicator lights red.

The table to the right provides samples of how the indicators light. Monitor the indicators on the front of the panel to check the power status.

Power On Indicator	Standby Indicator	Flat Panel TV Status
●	●	Panel's power cord is disconnected or the power cord is connected but the flat panel TV's Power On button (⏻) is off
☀	●	Power is on but waiting for activation
●	☀	Panel is in Standby

3.2 Program the Flat Panel TV for Television Viewing

To watch TV and take advantage of some built-in features, choose the channel type or types (Analog, Digital), select a language, set your time zone, and program the channels. The sections below include how to set your channel type and how to use the Home Menu for each programming option.

3.2.1 Choose Analog or Digital TV Channels

To choose a channel setting, note the antenna input terminal connected to the back of the panel. Follow the directions below to select analog or digital TV channels.

- 1) Confirm that the remote control is set to TV.
Located at the bottom of the remote control.
- 2) Press **TV/DTV** on the remote control.
Located at the top of the remote control.
- 3) Select a channel option, analog or digital.
*During operation, press **TV/DTV** to toggle between TV signals.*

Note: See "2.5.1 Add Analog (conventional) and Digital TV Channels" for more information about channel setting options.

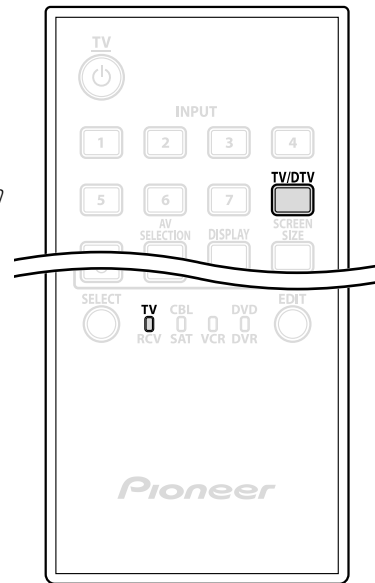

*Note: When watching TV and separate video image (multi-screen), pressing the remote control's **TV/DTV** button changes only the TV signal appearing on the left side of the panel.*

3.2.2 Explore the Home Menu

The Home Menu is the main menu for the flat panel TV. Most commands and settings are programmed through this menu. The following section describes a typical method for working with the panel's menus. For actual procedures, see the appropriate page(s) that describe a function.

- 1) Press **HOME MENU** on the remote to access the main menu.
- 2) Use the Up/Down arrows (\uparrow/\downarrow) to highlight a menu item.
- 3) Use the Left/Right arrows (\leftarrow/\rightarrow) to scroll through options for that menu item.
- 4) Highlight the selected menu option.
- 5) Press **ENTER** to lock in the change.
- 6) Press **RETURN** to move back to a previous menu/submenu page when changing more than a single option.
- 7) Press **HOME MENU** again to exit the menu screen.

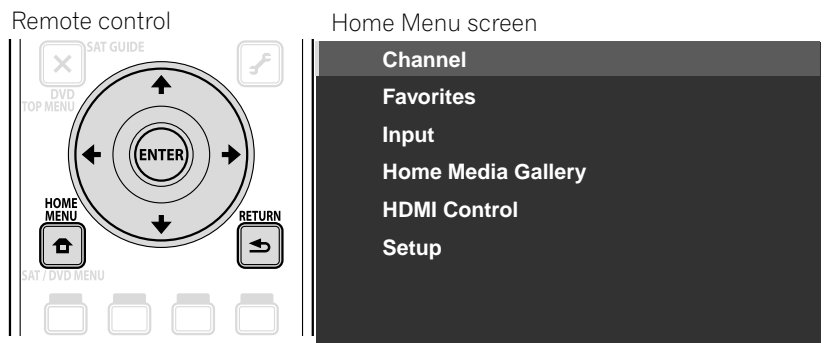

This chart provides a breakdown of the Home Menu for both AV and PC sources.

AV Source		Pg	Option
Channel		39	—
Favorites		39	—
Input		39	—
Home Media Gallery		83	—
HDMI Control		76	—
Setup	Picture	54	AV Selection
		58	Contrast*
		58	Brightness*
		58	Color*
		58	Tint*
		58	Sharpness*
		60	PureCinema
		46	Sound Control**
		45	OPTIMUM Performance**
	58	Reset	
	Sound	46	Treble
		46	Bass
		46	Balance
		67	Sound Effect
		46	Reset
		67	AVC
	Power Control	53	Energy Save
68		No Signal off	
68		No Operation off	
Sleep Timer		41	—
Option	44	Position	
	56	Auto Size	
	59	Side Mask	
	74	HDMI Input	
	81	HDMI Control Setting	
	53	Orbiter	
	53	Video Pattern	
	56	Game Control Pref	
	42	Room Light Sensor	
	52	Screen Protection	
	40	Label Input	
	System Setup	35	Auto Installation
		36	Analog TV Setup
38		Digital Tuner Setup	
47		Parental Control	
64		Closed Captions	
111		Digital Audio Output	
47		Change Password	
34	Language		
114	Technical Info		
Favorites Setup	39	Channel Mode	
	40	Sort Favorites	

PC Source		Pg	Option	
Channel		39	—	
Favorites		39	—	
Input		39	—	
Home Media Gallery		83	—	
HDMI Control		76	—	
Setup	Picture	54	AV Selection	
		58	Contrast	
		58	Brightness	
		58	Red	
		58	Green	
		58	Blue	
		58	Reset	
		Sound	46	Treble
			46	Bass
	46		Balance	
	67		Sound Effect	
	46		Reset	
	67		AVC	
	Power Control	53	Energy Save	
		68	Power Management	
	Sleep Timer		41	—
	Option	112	Auto Setup	
112		Manual Setup		
74		HDMI Input		
81		HDMI Control Setting		
53		Orbiter		
40		Label Input		
Favorites Setup	39	Channel Mode		
	40	Sort Favorites		

* Available when any option other than OPTIMUM is selected from the AV Selection menu.

** Available only when OPTIMUM is selected from the AV Selection menu

3.2.4 Set the Clock

Set the flat panel TV's clock to take advantage of many built-in features such as Time Zone and D.S.T. (Daylight Saving Time) activation for digital TV broadcast.

Note: If the panel's power cord is unplugged or there is a power outage, the time must be reset.

Follow the steps below to set the clock.

- 1) Access the *System Setup* through the *Setup*.
- 2) Select *Digital Tuner Setup* from the System Setup menu.
- 3) Select *Clock* from the Digital Tuner Setup menu.
- 4) Select *Time Zone* from the options.
- 5) Select the time zone for your area.

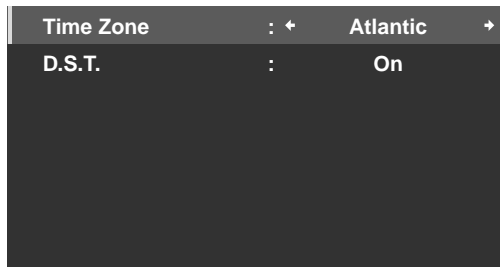

- 6) Select the menu option *D.S.T.* to activate/deactivate Daylight Saving Time.
- 7) Select the proper option for your location.
- 8) Press **HOME MENU** to close the menu and exit.

3.2.5 Create the List of Channels

This section describes how to search for and set up TV channels. There are two ways to add channels to your flat panel TV, Auto Installation for automatic channel selection or manual channel assignments. The Auto Installation adds all available channels from your selected TV provider. Once all channels are added to the list, simply delete any unwanted channels. This section provides steps to add/remove channels.

Auto Installation

Auto Installation searches for and adds TV channels to your list of viewable channels. Using the remote control, follow the steps below to automatically select all available channels.

- 1) Access the *System Setup* through the *Setup*.
- 2) Select *Auto Installation* from the System Setup menu.
- 3) Select *Air/Cable*, *Language*, or *Time Zone* from the Auto Installation menu.
- 4) Select an option.
 - Signal Type: *Air* or *Cable*
 - Language: *English*, *Français* or *Español*
 - Time Zone: *Atlantic*, *Eastern*, *Central*, *Mountain*, *Pacific*, *Alaska*, or *Hawaii*

5) Select *Start*.

The panel automatically begins creating your list of channels.

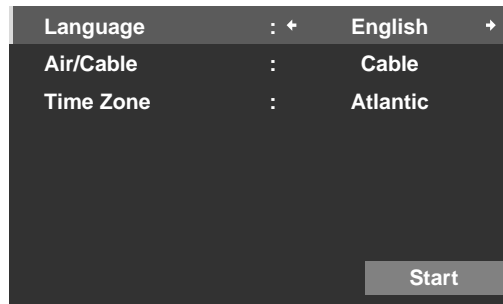

*Note: To quit Auto Installation before it is complete, press **RETURN** to recall the Auto Installation screen then **EXIT**.*

Manual Channel Selection

To add channels without using the Auto Installation option, follow the directions below. Also, if a channel is skipped in error, use this method to add the channel to your list.

- 1) Access the *System Setup* through the *Setup*.
- 2) Select *Analog TV Setup* from the System Setup menu.
- 3) Select *Manual Adjust* from the Analog TV Setup menu.
- 4) Select *Program Entry*.
- 5) Select a channel number to be added.
Use the arrow buttons (←/→) to enter a channel number.
- 6) Select *Store* from the Manual Adjust menu.
- 7) Select *Yes* from the submenu.

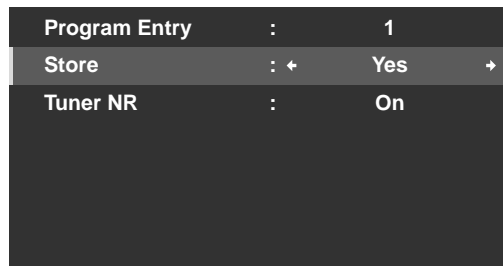

- 8) Press **HOME MENU** to exit the menu after all wanted channels have been added.

Note: Analog channels can be added manually but digital channels can only be added using the Add New Channels button on the Digital Tuner Setup menu.

Add New Channels

To add new channels, follow the steps below.

- 1) Access the *System Setup* through the *Setup*.
- 2) Select *Digital Tuner Setup* from the System Setup menu.

- 3) Select *Installation* from the Digital Tuner Setup menu.

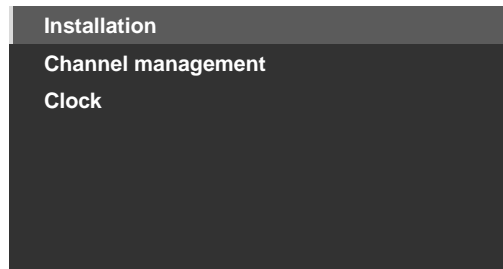

- 4) Select *Add New Channels*.
Channel search starts automatically. If a new channel is found, it is stored automatically in the flat panel TV.
To cancel channel search before it finishes, press RETURN.

Software Keyboard

This on-screen keyboard allows labeling manually added TV channels. Channel labels can be up to eight characters long to help channel identification.

To use the Software Keyboard for labeling TV channels, follow the steps below.

- 1) Access the *System Setup* through the *Setup*.
- 2) Select *Analog TV Setup* from the System Setup menu.
- 3) Select *Label* from the Analog TV Setup menu.
- 4) Select *Program Entry* from the submenu.
- 5) Select a program number.
 - Cable: 1 through 135
 - Air: 2 through 69
- 6) Select *Label*.
The Software Keyboard screen appears.

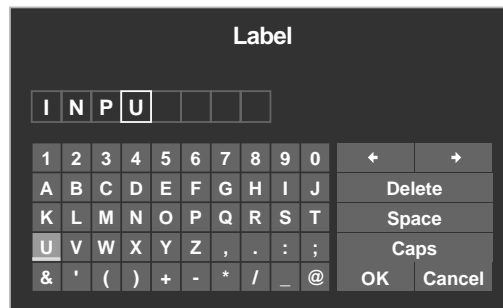



- 7) Select the first character.
The cursor moves to the next character space.
- 8) Repeat the previous step to enter up to eight characters.
 - To change a character, use ◀ or ▶ to highlight the character then press **ENTER**. The cursor moves to the previous or next character.
 - To delete the entered character, highlight the character, select **Delete** then press **ENTER**.
 - To put a space after the entered character, highlight the space, select **Space** then press **ENTER**.
 - To toggle between upper case and lower case, highlight the character, select **Caps** then press **ENTER**.
- 9) Select **OK** then press **ENTER**.
The entry is complete.
- 10) Press **HOME MENU** to exit the menu.

3.2.6 Skip or Delete Unwanted Channels

The Auto Installation process adds all channels available from your TV service provider. However, there may be some channels that are unwanted or are not age-appropriate for your home. This section explains how to bypass or delete unwanted channels when moving up/down one channel at a time and what programs are available for viewing.

To skip or delete unwanted channels, use the remote's **CH+/CH-** buttons to reset the status for those channels. Follow the steps below to change a channel's status.

- 1) Access the *System Setup* through the *Setup*.
- 2) Select *Digital Tuner Setup* or *Analog TV Setup* from the System Setup menu.
 - *Digital TV channels: Channel management > Channel Options >  (Channel Delete) > (On)*

Channel Name	Channel Number	Channel Status	Channel Action
XXXX	00001.000		
XXXX	00002.000	<input checked="" type="checkbox"/>	
XXXX	00003.000		
XXXX	00004.000		
XXXX	00005.000	<input checked="" type="checkbox"/>	
XXXX	00006.000		
XXXX	00007.000	<input checked="" type="checkbox"/>	
XXXX	00008.000		
XXXX	00009.000		

- 3) Scroll to or highlight an unwanted channel number.
- 4) Press **ENTER** to reverse the status for that channel.
When there is a check mark next to the channel, it disappears.
- 5) Press **RETURN**.
A confirmation screen appears.
- 6) Select *Yes* then press **ENTER**.
The Channel Delete setting is complete.
- 7) Press **HOME MENU** to exit the menu.
If you select the  (Channel Skip) option in Step 3, the setting is complete when exiting the Channel Options menu (no confirmation screen appears). Skip Steps 5 and 6.

The instructions for restoring a skipped channel are the same as above. In Step 4 a check mark appears next to the added/restored channel.

To skip an analog channel, follow the steps below.

- *Analog TV channels: Manual Adjust > Store > No*

Radio Skip

This function allows skipping of radio channels at a time. To set this option, follow the steps below.

- 1) Access the *System Setup* through the *Setup*.
- 2) Select *Digital Tuner Setup* from the System Setup menu.
- 3) Select *Channel management* from the Digital Tuner Setup menu.
- 4) Select *Radio Skip* from the Channel management menu.
- 5) Select *On*.
- 6) Press **HOME MENU** to exit the menu.

3.2.7 Channel List

Your flat panel TV offers three channel lists for quick access to a desired channel: Favorites List, Channel List and Input List.

Favorites List: Display your favorite channel numbers/names up to 20 channels (analog channels, Input 1 through 7, PC), 20 digital channels, and 1 Home Media Gallery

Store your most frequently viewed channels in the Favorites List.

To display the Favorites List, press **ENTER** while showing a TV channel. For another method to access the Favorites List, follow the directions below.

- 1) Press **HOME MENU**.
- 2) Select *Favorites* from the main menu.
Pressing the **←/→** button while showing the Channel List or Input List also causes the Favorites List to appear.

Channel List: Display all analog/digital TV channels in each broadcast network group

To display the Channel List, follow the directions below.

- 1) Press **HOME MENU**.
- 2) Select *Channel* from the main menu.
Pressing the **←/→** button while showing the Favorites List or Input List also causes the Channel List to appear.

Input List: Display external input source names from INPUT 1 through INPUT 7 and PC

To display the Input List, follow the directions below.

- 1) Press **HOME MENU**.
- 2) Select *Input* from the main menu.
Pressing the **←/→** button while showing the Favorites List or Channel List also causes the Input List to appear.

*Note: After selecting the desired channel, pressing **ENTER** causes the Channel List to close and the selected screen appears. Pressing **RETURN** or **EXIT** causes the Channel List to close and the screen before selection returns.*

Press an arrow button to cycle through the lists when viewing any of the lists.

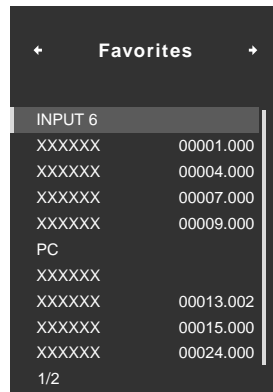

Set Favorite Channels

Select up to ten (10) channels per list page, up to five pages for a total of 41 favorite channels. To assign channels to your *Favorites* or *All*, follow the steps below.

- 1) Access the *Favorites Setup* through the *Setup*.
- 2) Select *Channel Mode* from the Favorites Setup menu.
- 3) Select *All* or *Favorites* from the Channel Mode menu.
 - To assign all channels, select *All*. To assign the registered channels, select *Favorites*.

- 4) Select a TV channel to store.

If the screen fails to fit in the window, a scroll bar appears.

*Pressing **ENTER** while watching a TV program also causes the favorite channel list to appear. If the Favorites List is empty, "No Favorites List." appears.*

- 5) Press **HOME MENU** to exit the menu.

Alternate Method to Store Your Favorite Channels

Use the TOOLS Menu to store TV channels, external input sources including PC, and Home Media Gallery contents. To store channels, follow the steps below.

- 1) Press **TOOLS**.

The TOOLS Menu appears on screen.

- 2) Select *Favorites Entry*.

Use the arrow buttons to highlight an option.

- 3) Select *On (←/→)*.

The channel you are watching is stored in the favorite list.

To cancel, use the arrow button to select Off.

Notes:

- Pressing **EXIT**, **RETURN**, or **TOOLS** again causes the TOOLS Menu to disappear.
- Once the maximum number of channels are stored, a warning screen appears.
- To quit the procedure before it finishes, press **EXIT** or **RETURN** on the remote control.

Sort Favorite Channels

To sort through the stored channels, follow the steps below.

- 1) Access the *Favorites Setup* through the *Setup*.

- 2) Select *Sort Favorites* from the Favorites Setup menu.

- 3) Select a channel to move.

- 4) Select a new location then press **ENTER**.

The selected channel is moved to the new location. To sort another channel(s), repeat Steps 3 and 4.

- 5) Press **HOME MENU** to exit the menu.

Edit the Input List

To change name of an Input, follow the steps below.

- 1) Access the *Option* through the *Setup*.

- 2) Select *Label Input* from the Option menu.

- 3) Select an input or PC.

The software keyboard appears.

- 4) Enter the new name.



- 5) Select *OK* to save the name and exit the menu.

*To cancel, press **HOME MENU**.*

3.3 Quick Start for Watching Television

Your flat panel TV has many functions and features, some of which you may simply lack the time to set when first installing the panel. To begin watching TV quickly, refer to the basic information within this section. However, when it is convenient, we strongly suggest going through the rest of this manual and learning all that your flat panel TV can do.

3.3.1 Change the Channel/Sub-Channel

With the remote control pointed at the panel's remote sensor, press the **CH +** button to sequentially change to the next highest available channel. The **CH –** button sequentially changes down to the next lowest available channel. Each press of **CH +** or **CH –** causes the channel to change sequentially from station to station. To return to the previous channel, press **CH RETURN**. To toggle between the two channels, press **CH RETURN** again. Each press of this button switches the channel between these two stations.

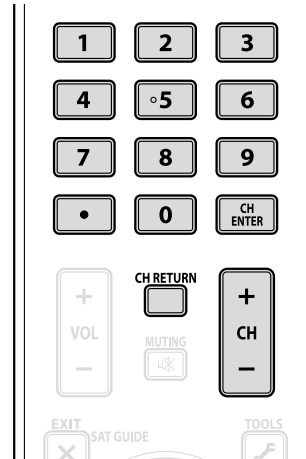

Another option for changing the channel is to use the number buttons (**0** through **9**). Simply press the number buttons in the order needed for that channel. For example, enter Channel 231 as **2 - 3 - 1** or Channel 4 as the single number, **4**.

A recent addition to TV viewing is the Sub-channel. A digital channel can be split in to multiple signals. Each signal, called a sub-channel, can carry a different program. To watch a sub-channel, use a combination of number buttons and the dot (.) button. For example, if Channel 5 is digital and has three active sub-channels, enter **5 . 2** to reach the second sub-channel.

*Note: To tune in a program more quickly, enter the channel or sub-channel then press **CH ENTER**.*

3.3.2 Adjust the Volume/Sound

With the remote control pointed at the panel's remote sensor, press and hold **VOL+** to increase the sound volume gradually. Holding down **VOL–** decreases the volume at the same rate. A single press of **VOL+** or **VOL–** causes the volume to adjust by minor increments.

To silence all sound, press **MUTING**. The muting symbol (⊘) appears on screen. To return the volume to the previous level, press **MUTING** again. Pressing **VOL+** once also increases the volume one step higher than the current level and cancels the muting mode.

If the panel's default sound level is too loud or too soft, refer to "3.4.6 General Sound (Audio) Adjustment."

3.3.3 Turn On the Sleep Timer

To save energy and to maximize the life of your flat panel TV, try using the Sleep Timer for occasions when the panel may be left on by accident. The Sleep Timer places the panel in Standby when the selected time elapses. The Sleep Timer provides time periods of 30, 60, 90, or 120 minutes. When the Timer is down to five minutes, a reminder appears on screen each minute until the time has elapsed.

To set the Sleep Timer, follow the steps below.

- 1) Access the *Sleep Timer* through the *Setup*.
- 2) Select the desired time period.
Select between 30 minutes and 2 hours (120 minutes).
- 3) Press **HOME MENU** to exit the menu.

The SLEEP indicator on the front of the flat panel TV lights orange when the Sleep Timer is set. To check the remaining time, press **TOOLS** then select Sleep. "Remain ---min" appears at the top of the menu screen. After checking the time, press **EXIT** to return to your program without losing the Sleep Timer setting.

Note: When the sleep timer has been set, "Remain ---min" appears at the top of the menu. However, the Video Pattern timer has priority over the sleep timer. When the Video Pattern timer is on, the sleep timer is deactivated. Video Pattern is explained fully later in this manual.

3.4 Adjust the Picture and Sound Quality

Your flat panel TV has many adjustment options for the picture and the sound to make it just right for you. This section provides basic adjustments but for detailed video/audio modifications, refer to "4 Additional Picture and Sound Adjustment Options" and "4.7 Select Alternatives for/to Sound."

3.4.1 Adjust the Picture for Your Room Lighting

The flat panel TV senses the amount of light in your room and automatically adjusts the screen brightness for the best picture. Bright rooms require stronger coloring so images appear crisp while dimly lit rooms allow the picture to use more subtle coloring.

The panel ships with the Room Light Sensor turned Off. The sections below provide directions to turn the room lighting sensor On/Off.

Room Lighting Sensor

To deactivate/reactivate the room lighting sensor, follow the steps below.

- 1) Access the *Option* through the *Setup*.
- 2) Select *Room Light Sensor* from the Option menu.
- 3) Select *On* (or *Off*) from the submenu.

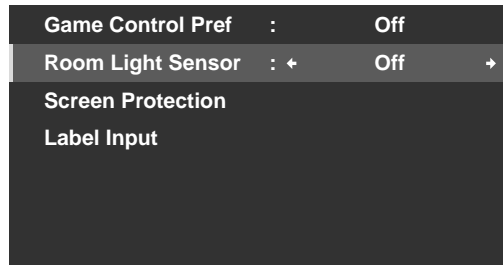

- 4) Press **HOME MENU** to exit the menu.

3.4.2 General Picture (Video) Adjustment for an AV Source

The directions below apply to all AV sources except OPTIMUM and DYNAMIC. If the viewing option is OPTIMUM, your flat panel TV automatically adjusts the picture to the best possible level. If the preferred viewing option is DYNAMIC, please refer to "4.1 Choose an AV Option (Video, Game, etc.)." For standard picture adjustments, follow the steps below.

- 1) Access the *Picture* through the *Setup*.
- 2) Select an item to be adjusted.
Contrast is used in the example below.



- 3) Use the arrow buttons (←/→) to adjust to the desired level.



- 4) Press **HOME MENU** to exit the menu.

Reduce Noise from Analog TV

Sometimes electronic signal static can cause imperfections in the picture. This static is called Video Noise. Your flat panel TV can reduce video noise from an analog TV channel, depending on the broadcast signal level. Sometimes the broadcast signal has higher interference levels so that some video noise is noticeable. This function is only selectable for signals from an antenna. Follow the steps below to reduce noise on an analog TV channel.

- 1) Access the *System Setup* through the *Setup*.
- 2) Select *Analog TV Setup* from the System Setup menu.
- 3) Select *Manual Adjust* from the submenu.
Only analog channels set using Auto Installation are manually adjustable.
- 4) Select *Program Entry*.
- 5) Select a channel number to be added.
Use the arrow buttons (←/→) to enter a channel number.
- 6) Select *Tuner NR*.
- 7) Select *On*.
The default setting is On.
- 8) Press **HOME MENU** to exit the menu.

Picture Image Position

Each input source stores the picture adjustment settings for that view. Although repositioning is available in most screen views, when the screen is set to Dot-by-Dot, the Position menu is unavailable. Also, depending on the displayed video, the image position may not change after an adjustment.

To adjust the picture's horizontal and vertical position, follow the steps below.

- 1) Access the *Option* through the *Setup*.
- 2) Select *Position* from the Option menu.

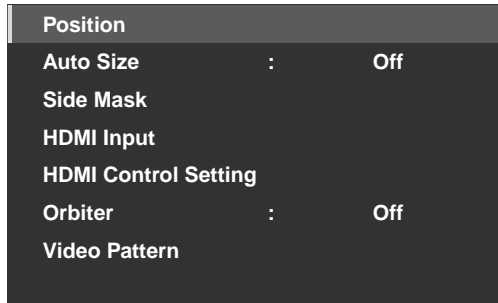

- 3) Select *H/V Position Adjust* from the submenu.
- 4) Adjust the vertical and/or horizontal positioning using the arrow buttons.
- 5) Press **HOME MENU** to exit the menu.

Restore Default Picture

After making multiple adjustments, it may be difficult to reverse improper settings. To restore the factory default video settings, follow the directions below.

- 1) Highlight *Reset* from the Picture menu.
- 2) Press **ENTER** to continue with the picture reset.
A confirmation screen appears asking if settings should be returned to the factory defaults.
- 3) Use the arrow buttons to highlight *Yes*.
- 4) Press **ENTER**.
All video settings return to the original default values when selecting options other than OPTIMUM or PC. When OPTIMUM is selected, video settings for OPTIMUM, AV Selection menus, and Sound Control settings return to the original default values.

3.4.3 Compare Images When Adjusting the Picture

When adjusting the picture, look for an overall improvement by adjusting each parameter or option one at a time. Many small adjustments lead to the best picture for your viewing area. As each option changes, refer back to the previously set image for comparison. This section includes adjustment notes and steps to adjust the flat panel TV's picture.

Each parameter/option must be adjusted separately. For example, if two options under AV Selection, PERFORMANCE and MOVIE need adjustment, change/compare one option then save the preferred setting before moving on to the other option. Below are other guidelines to follow when adjusting the picture.

- Adjustments are available while on the *After* screen. Trying to make adjustments while on the *Before* causes a warning message to appear.
- Switch to another parameter/option only from the *After* screen. If viewing the *Before* screen when selecting another option, the *Before* data is lost.
- Exiting an option from the *Before* screen stores that previous entry in memory and deactivates the **TOOLS** button.
- Exiting an option from the *After* screen stores the new entry in memory and deactivates the button.

- Moving/changing the AV Selection parameter/option stores the option setting in memory (button continues to work).

Follow the steps below to adjust options for the preferred picture quality.

- 1) Access the *Picture* through the *Setup*.
- 2) Select an option.
- 3) Use the **TOOLS** button to toggle between the previous and adjusted images.
- 4) Repeat Steps 2 and 3 to continue adjusting the option as needed.
- 5) Repeat Steps 2 through 4 to adjust other picture options.
- 6) Press **HOME MENU** to exit the menu.

Note: if no selections are made within 60 seconds, the menu closes automatically and the current settings are saved to memory.

To exit the menu without saving the changes, switch to the *Before* screen then press **HOME MENU**.

3.4.4 Display a Graphical Picture/Sound Adjustment Screen

Selecting *OPTIMUM* from the AV Selection menu causes the Picture menu to display different AV source submenus. Select *On* for the Sound Control option to automatically adjust the sound quality, and *OPTIMUM Performance* provides an on-screen graphic monitor for multiple picture and sound adjustments.

OPTIMUM Performance

OPTIMUM Performance displays on-going picture and sound adjustments using graphical data when selecting OPTIMUM from the AV Selection menu. OPTIMUM Performance provides the following bar graph data:

- Analyzer: Histogram, RGB, Room Light
- Picture: Contrast, Brightness, Color, Sharpness, Color Temp., Gamma
- Sound: Level



To display OPTIMUM Performance, follow the procedure below.

- 1) Access the *Picture* through the *Setup*.
- 2) Select *AV Selection* from the Picture menu.
- 3) Select *OPTIMUM* from the AV Selection menu.
- 4) Select *OPTIMUM Performance* from the Picture menu.
The OPTIMUM Performance appears. To cancel the OPTIMUM Performance option, press EXIT.

*Note: When OPTIMUM is selected, press and hold **DISPLAY** on the remote control to show OPTIMUM Performance.*

*OPTIMUM Performance compares the picture and sound quality between "Off" (unadjusted) and "On" (adjusted using the **TOOLS** button).*

3.4.5 Sound Control

Setting the Sound Control option to *On* automatically adjusts to the highest sound quality possible for the selected image and viewing environment. This option is also available when *OPTIMUM* is selected in the AV Selection menu. To activate Sound Control, follow the procedure below.

- 1) Access the *Picture* through the *Setup*.
- 2) Select *AV Selection* from the Picture menu.
- 3) Select *OPTIMUM* from the AV Selection menu.
- 4) Select *Sound Control* from the Picture menu.
- 5) Select *On*.
- 6) Press **HOME MENU** to exit the menu.

Note: When Sound Control from the Picture menu is selected, the only Sound menu option available is AVC (Auto Volume Control).

3.4.6 General Sound (Audio) Adjustment

Many prefer a heavier base when watching movies or music videos from an AV source or on TV. Others like a more balanced sound. To adjust the sound to your preference, follow the directions below.

- 1) Access the *Sound* through the *Setup*.
- 2) Select an option for adjustment.

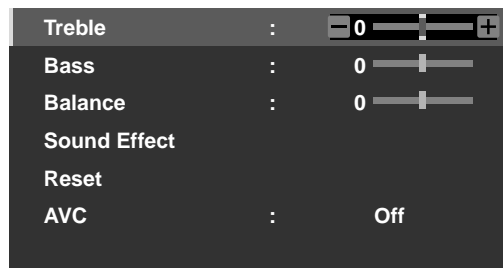

- 3) Use the left/right arrow buttons (←/→) to adjust the option.

Option	Left Button	Right Button
Treble	weakens tone	strengthens tone
Base	weakens tone	strengthens tone
Balance	shifts audio balance to the left	shifts audio balance to the right

- 4) Press **HOME MENU** to exit the menu.

Restore Default Sound Settings

To restore the factory default sound settings, follow the directions below.

- 1) Highlight *Reset* from the Sound menu.
- 2) Press **ENTER** to continue with the sound reset.
A confirmation screen appears asking if settings should be returned to the factory defaults.
- 3) Use the arrow buttons to highlight *Yes*.
- 4) Press **ENTER** to restore all sound settings to the original default values.

Note: The Auto Volume Control (AVC) setting cannot be restored to the factory default.

3.5 Block Programs, Channels, or Content

Although blocking programs, channels, or content is optional, some images may be inappropriate for all family members. Your flat panel TV supports a blocking function known as Parental Control. With Parental Control activated, certain material fails to appear on screen if it is beyond your select viewing level. Parental Control uses recognized rating systems but also allows blocks placed at your discretion. This section explains the different blocking functions and how to assign each type.

Note: When watching a TV program, you may see an emergency alert message scrolling at the top of the screen. The television station is broadcasting the emergency message as a test or an alert in a real emergency. The flat panel TV ships with this function active. For information about emergency messages, refer to "3.5.3 Assign a Rating System to Create Blocks."

3.5.1 Assign a Parental Control (Block) Password

With Parental Control, inappropriate TV programs, VCR recordings, and DVD content can be blocked. When someone attempts to watch a blocked program or content, the flat panel TV displays the password window. Parental Control applies to both analog and digital material.

To ensure that your blocks are not removed in error, the flat panel TV requires a password to change access to blocked programs, channels, or content. The default password for your panel is 1234. We strongly recommend changing the password to a four-digit code that is meaningful to you.

Follow the steps below to change the password.

- 1) Access the *System Setup* through the *Setup*.
- 2) Select *Change Password* from the System Setup menu.

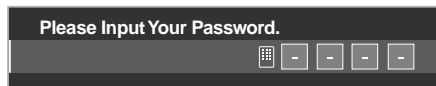

- 3) Enter the current four-digit code using the **0** through **9** buttons.
A confirmation message appears on screen.
- 4) Enter your new password.
- 5) Enter your new password a second time when prompted.
- 6) Press **HOME MENU** to exit the menu.

<p>Write your new password:</p> <div style="display: flex; gap: 10px;"> <input style="width: 30px; height: 30px; border: 1px solid black;" type="text"/> <input style="width: 30px; height: 30px; border: 1px solid black;" type="text"/> <input style="width: 30px; height: 30px; border: 1px solid black;" type="text"/> <input style="width: 30px; height: 30px; border: 1px solid black;" type="text"/> </div>	<p><i>If you forget your password: When "Enter your Password" appears at Step 4, press and hold the ENTER button for three or more seconds. The password reverts to the default password, 1234.</i></p>
--	---

3.5.2 Activate Parental Control

The Parental Control function must be active for the panel to block content. If this option is turned Off, blocked programs appear on screen. To activate Parental Control blocking, follow the steps below.

- 1) Access the *System Setup* through the *Setup*.
- 2) Select *Parental Control*.
The password entry screen appears.
- 3) Enter your four-digit code using the **0** through **9** buttons.
- 4) Select *Status*.

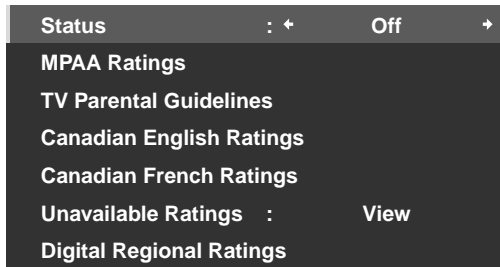

- 5) Select *On* to activate Parental Control.
- 6) Press **HOME MENU** to exit the menu.

When a program is blocked, a **(B)** appears next to the channel number. If a channel is blocked but the Parental Control system is turned off, the symbol is a **(V)** and the channel/program is viewable.

The lock symbol here marks blocked TV ratings.

	FV	D
B		
B		
B	B	
V		

3.5.3 Assign a Rating System to Create Blocks

Besides choosing to block certain channels, you may use one of the recognized rating systems to block programs and/or content. Your panel recognizes the following rating systems:

- TV ratings
- TV Parental Guidelines including unrated programming
- Motion Picture Association of America (MPAA for movies)
- Canadian English/French rating systems

Note: Your flat panel TV ships with all ratings unblocked.

To block TV or other content using a rating system, follow the steps below.

- 1) Access the *System Setup* through the *Setup*.
- 2) Select *Parental Control* from the System Setup menu.
- 3) Select one of the rating systems from the submenu.

MPAA Ratings menu

N/A	: ←	View	→
G	:	View	
PG	:	View	
PG-13	:	View	
R	:	View	
NC-17	:	View	
NR	:	View	

TV Parental Guidelines menu

	B	FV	D	L	S	V
TV-None	B					
TV-Y	B					
TV-Y7	B	B				
TV-G	V					
TV-PG	V		V	V	V	V
TV-14	V		V	V	V	V
TV-MA	V			V	V	V

Canadian English Ratings menu

E	: ←	View	→
C	:	View	
C8+	:	View	
G	:	Block	
PG	:	Block	
14+	:	Block	
18+	:	Block	

Canadian French Ratings menu

E	: ←	View	→
G	:	View	
8 ans+	:	View	
13 ans+	:	View	
16 ans+	:	View	
18 ans+	:	View	

Unavailable Ratings menu

Status	:	Off	
MPAA Ratings			
TV Parental Guidelines			
Canadian English Ratings			
Canadian French Ratings			
Unavailable Ratings	: ←	View	→
Digital Regional Ratings			

Digital Regional Ratings menu

Status	:	Off
MPAA Ratings		
TV Parental Guidelines		
Canadian English Ratings		
Canadian French Ratings		
Unavailable Ratings	:	View
Digital Regional Ratings		

- 4) Use the arrow buttons to highlight a block level for that rating system.
- 5) Press **ENTER** to reverse the blocked status for the highlighted TV Parental Guideline option.
A block (**B**) or view (**V**) symbol appears in appropriate rating boxes. For other rating options, press **←/→** to toggle between block and view.
- 6) Press **HOME MENU** to exit the menu.

When a rating is blocked, all more severe ratings are blocked as well. For example, blocking TV rating TV-PG (Parental guidance suggested) automatically blocks TV-14 (Parents strongly cautioned) and TV-MA (Mature audiences only). In turn, unblocking a rating causes less severe ratings to become automatically available.

Program Rating of "None"

The flat panel TV also provides a rating setting that blocks programs with a rating of *None*. The US TV Parental Guidelines Rating system identifies programs with a *None* rating level. Examples of programs with a rating of *None* are as follows:

- Emergency Bulletins (such as EAS messages, weather warning and others)
- Locally originated programming
- Public Service Announcements
- News
- Politics
- Religion
- Sports

To block a program with a rating of *None*, follow the steps below.

- 1) Access the *System Setup* through the *Setup*.
- 2) Select *Parental Control* from the System Setup menu.
- 3) Select *TV Parental Guidelines* from the Parental Control menu.
- 4) Select *TV-None* from the submenu.
- 5) Select an option (*View* or *Block*).
- 6) Press **HOME MENU** to exit the menu.

Refer to "8.1 Ratings Charts (for Various Audience Classifications)" for detailed information about the different rating systems.

Block Not Rated Programs

With some TV programs, the rating information is unavailable. To block these programs, follow the steps below.

- 1) Access the *System Setup* through the *Setup*.
- 2) Select *Parental Control* from the System Setup menu.
- 3) Select *Unavailable Ratings* from the Parental Control menu.
- 4) Select an option (*View* or *Block*).
- 5) Press **HOME MENU** to exit the menu.

Note: Your flat panel TV ships with this option set to View.

New Ratings System for Digital Broadcasts

Some Digital broadcasts carry new ratings that are not compatible with the panel's original Parental Control settings. When first tuning to one of these broadcasts, the Digital Regional Ratings menu appears on screen. Change the Parental Control settings to handle the new ratings. Otherwise, previous blocked ratings may become unblocked.

Note: Adding the new rating does not cause programs with this rating system to be blocked automatically.

To add the new rating system to your panel, follow the directions below.

- 1) Access the *System Setup* through the *Setup*.
- 2) Select *Parental Control* from the System Setup menu.
- 3) Select *Digital Regional Ratings* from the submenu.
A list of available ratings appears.
- 4) Select from the available ratings.
- 5) Select a level from the available ratings.
- 6) Select *View* or *Block*.
- 7) Press **HOME MENU** to exit the menu.

Delete a New Ratings System

If an added ratings system is no longer needed, delete the ratings system from your flat panel TV. It is unnecessary to remove blocks from individual channels or programs. Deleting the ratings line removes any/all blocks initiated with that system.

- 1) Access the *System Setup* through the *Setup*.
- 2) Select *Parental Control* from the System Setup menu.
- 3) Select *Digital Regional Ratings* from the submenu.
- 4) Select *RRT Reset* to delete the new ratings system from the flat panel TV.
The message "Reset digital regional ratings?" appears.
- 5) Select *OK*.
- 6) Press **HOME MENU** to exit the menu.

While the Parental Control menu is open, the status display remains unchanged even if the system receives broadcasts carrying new ratings.

3.5.4 Temporarily Remove a Block

The password entry screen appears when detecting the blocked rating signals (with the picture and sound turned off). Entering your four-digit password allows you to view the program until your flat panel TV is placed into Standby or turned Off. To temporarily remove a block, follow the steps below.

- 1) Tune the flat panel TV to the blocked channel.
- 2) Wait for the Block message to appear on screen.
- 3) Enter the four-digit password.
The password window appears. When a four-digit password is entered, or no operation is performed within 60 seconds, the window disappears. To recall the window after it disappears, change the channel or input source then return before repeating the above steps.

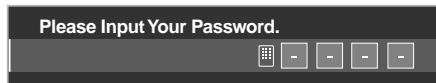

For INPUT 2 (except 480i signals) and INPUT 4 through INPUT 7, the password entry screen appears when *Block* is selected from the Unavailable Ratings menu.

3.6 Smart Starts for New Owners

Many of the flat panel TV features make it easy to use but also environmentally friendlier. This section explains how to extend the life of your panel while being energy efficient. We suggest applying all of the following functions below for the simplest usage, best quality, and longest life span.

3.6.1 Use the TOOLS Menu

To change the current menu to another option, the on-screen TOOLS Menu provides short-cuts to the available selections even while watching a program. To display the menu, press **TOOLS** on the remote control. The menus shown in this section differ, depending upon the menu.

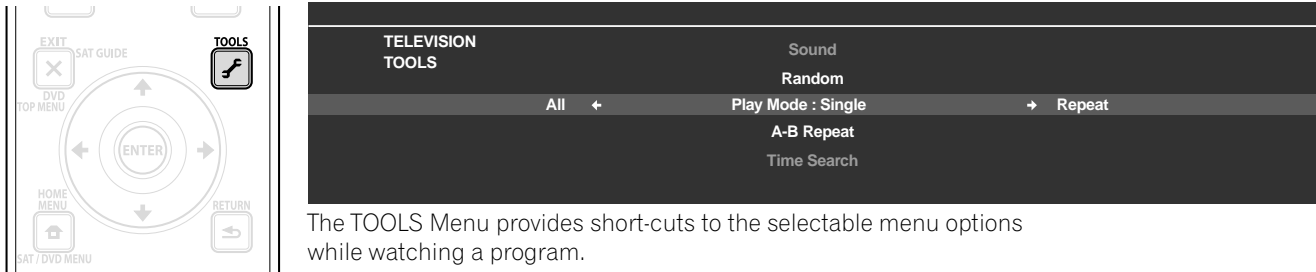

The TOOLS Menu provides short-cuts to the selectable menu options while watching a program.

Use the arrow buttons to toggle between options. The setting is complete as soon as the selected option appears in the center of the screen. When showing two screens, the TOOLS Menu appears on the main screen.

3.6.2 Extend Your Panel Life

This function provides short-cuts to your panel's longer service life. Your flat panel TV includes the Screen Protection option. Activating this option causes the panel to automatically select the several different features that can prolong the life of your panel and help alleviate after-image ghosts or burn-in. To set this option, follow the steps below.

- 1) Access the *Option* through the *Setup*.
- 2) Select *Screen Protection* from the Option menu.
A confirmation screen appears.
- 3) Select *Yes* from the submenu.
The following settings are automatically entered:
 - *Auto Size: Wide-Zoom*
 - *Side Mask - Detection: Mode 1*
 - *Orbiter (AV source): Mode 1*
 - *Orbiter (PC source): Mode 1*
 - *Energy Save: Mode 1*
 - *AV Selection: OPTIMUM (when DYNAMIC is selected for AV Selection)*
- 4) Press **HOME MENU** to exit the menu.



3.6.3 Turn On the Image Orbiter

A built-in feature to protect against burn-in is the Orbiter function. Orbiter automatically changes the position of the picture imperceptibly while the image is on screen. To activate the Orbiter, follow the steps below. To cancel this function, select Off in Step 3.

- 1) Access the *Option* through the *Setup*.
- 2) Select *Orbiter* from the *Option* menu.
- 3) Select *Mode 1* or *Mode 2*.
 - *AV source Mode 1: for any screen mode except Dot by Dot*
 - *AV source Mode 2: for all available screen modes*
 - *PC source Mode 1: to enable Orbiter*
 - *PC source Mode 2: to smooth the text/character appearance*
- 4) Press **HOME MENU** to exit the menu.

Note: The farthest edges of an image may be hidden at times as the picture position shifts. Also, when the Orbiter function is set to Mode 1 or Mode 2, the image may appear to drop slightly on the screen.

3.6.4 Trigger the Screen-Saving Video Pattern Periodically

The Video Pattern function causes the screen to appear white, which helps to alleviate after-image ghosts or burn-in. While the Video Pattern screen is on, only the remote's **TV** () button and the panel's **STANDBY/ON** button are available. The panel automatically switches to Standby one hour after running the Video Pattern screen. To cancel the Video Pattern screen, press the remote's **TV** () or press the panel's **STANDBY/ON**.

To activate the Video Pattern screen, follow the steps below.

- 1) Access the *Option* through the *Setup*.
- 2) Select *Video Pattern* from the *Option* menu.
A confirmation screen appears.
- 3) Select *Start* from the submenu.
The Video Pattern screen appears.
- 4) Leave the panel alone for a minimum of one hour.

Note: The Video Pattern timer has priority over Sleep Timer, No Signal off, and No Power off (Power Management) settings.

3.6.5 Activate Energy Save to Reduce Power Usage

The Energy Save option decreases picture brightness and lowers power consumption. The recommended setting, Energy Save Mode 1, extends the life of your panel while keeping power usage at a minimum.

Follow the steps below to activate an Energy Save option.

- 1) Access the *Power Control* through the *Setup*.
- 2) Select *Energy Save* from the menu.
- 3) Select an option from the Energy Save submenu.

Option	Description
Off	No effect
Mode 1	consumes less power than Off
Mode 2	consumes less power than Mode 1

- 4) Press **HOME MENU** to exit the menu.

4 Additional Picture and Sound Adjustment Options

To take advantage of all that your flat panel TV offers, browse this chapter for features and functions that enhance your viewing experience. Most sections deal with adjusting the picture and arranging screen/menu items while the remaining sections provide sound and power management options. Apply as many or as few of these changes as desired.

4.1 Choose an AV Option (Video, Game, etc.)

Similar to the purpose for the room light sensor, the AV Option or Selection depends upon the brightness of the environment and the program or movie on screen. Images can be from either an AV Source or from a PC. Both sources are discussed below.

Choose from among the seven AV Selections for the best image from an external AV Source. Use either the remote control or the Home Menu to select the AV source. For a PC, skip down to "4.1.3 Choose a PC Source." If the AV source is a Game Control, select GAME and refer to "4.1.4 Set the Panel to Recognize a Game Console" for more information.

4.1.1 AV Source through the Remote Control

Follow the directions below to set an AV Selection for an external AV Source using the remote control.

- 1) Press **AV SELECTION** on the remote control.
The current AV selection appears.
- 2) Press **AV SELECTION** again before the displayed mode disappears.
Each press cycles the options in the order shown below.

AV Selection	Description
OPTIMUM	automatically adjusts the image quality for the brightness level of the viewing area (shared by external input and TV input sources)
PERFORMANCE	for a highly defined image in a normally bright room (shared by external input and TV input sources)
DYNAMIC	for a very sharp image with maximum contrast but manual image quality adjustment unavailable (shared by external input and TV input sources)
MOVIE	for movies (shared by external input and TV input sources)
SPORT	for sports programs (shared by external input and TV input sources)
GAME	lowers image brightness for easier viewing (shared by external input and TV input sources)
Standard	allows customizing settings as desired (set the mode for each input source)

- 3) Allow the AV Selection screen to disappear.
When the screen disappears, the panel locks in last viewed option and the menu closes.

4.1.2 Choose an AV Source through the Home Menu

The other method for choosing an AV Selection uses the Home Menu. Follow the directions below to set an AV Selection for an external AV Source.

The AV Selection, OPTIMUM, automatically adjusts to the highest image quality possible for the selected source and viewing environment. Your flat panel TV employs advanced sound reproduction technologies, such as SRS WOW HD™, OPTIMUM also automatically adjusts to the optimum sound for the selected scene. This process is gradual so changes to the tint and brightness may be visible. This is normal and is not a malfunction.

DYNAMIC locks out manual adjustments for specific options. The DYNAMIC setting blocks Contrast, Brightness, Color, Tint, Sharpness, and Reset. Unavailable options are dimmed on the menu.

To choose an AV source through the Home Menu, follow the steps below.

- 1) Access the *Picture* through the *Setup*.
- 2) Select *AV Selection* from the *Picture* menu.
- 3) Select an option from the submenu.

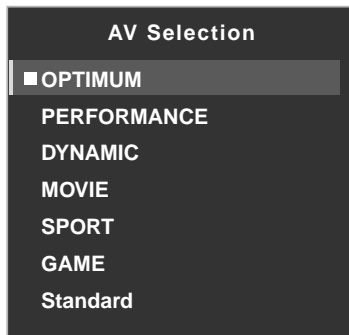

When OPTIMUM is selected, images are reproduced based on the information collected at the Room Light Sensor.

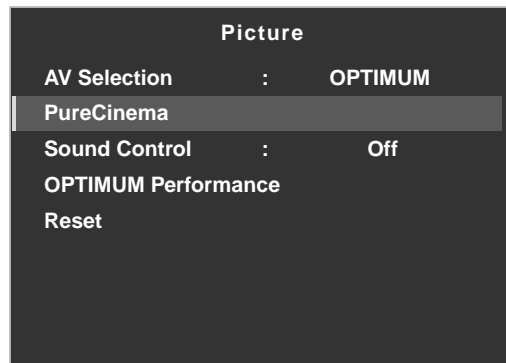

(Submenu when *OPTIMUM* is selected for AV Selection)

- 4) Press **HOME MENU** to close and exit the menu.

4.1.3 Choose a PC Source

From a PC, choose between the two AV Selections for the best image. The options are as follows:

- STANDARD: for a highly defined image in a normally bright room
- USER: allows customizing settings as desired for each input source

4.1.4 Set the Panel to Recognize a Game Console

When adding a game console to your flat panel TV, use the Game function to establish a preference for image quality or for operability.

To have the panel store your Game preference, follow the steps below.

- 1) Access the *Option* through the *Setup*.
- 2) Select *Game Control Pref* from the menu.
- 3) Select *On* (operability preferred) or *Off* (image quality preferred).
- 4) Press **HOME MENU** to exit the menu.

To activate the *Game Control Pref* option, set the AV Selection to GAME and use an external input (unless the source is coming from a PC). When a PC source menu is on screen, the *Game Control Pref* option is ignored. Also, the *Game Control Pref* option for operability (on) is ignored during multi-screen viewing (refer to "4.4 View in Multi-Screen") or image freezing (refer to "4.5 Freeze the Picture").

4.2 Adjust Specific Picture Elements

Plasma technology delivers one of the best images available today. However, the viewing area/environment and personal preferences affect how the picture appears. This section provides methods to adjust the picture and sound for your best viewing experience.

4.2.1 Choose a Screen Size (Automatically or Manually)

Automatic Screen Sizing

The flat panel TV can automatically select an appropriate screen size for the incoming video signal from a connected HDMI device. To allow automatic screen sizing, follow the steps below.

- 1) Access the *Option* through the *Setup*.
- 2) Select *Auto Size* from the Option menu.
- 3) Select *Natural* or *Wide-Zoom* from the submenu.

Option	Description
Off	deactivates the Auto Size function
Natural	adjusts the image to the screen size
Wide-Zoom	enlarges and displays only the 4:3 aspect ratio portion in full and wide screen

- 4) Press **HOME MENU** to exit the menu.

Note: When a video signal contains no aspect ratio information, the Automatic Screen Size function is unavailable.

Manual Screen Sizing

Manually select an appropriate screen size if an image fails to appear in the correct format. Browse the menu for the correct screen size for a specific program.

The selectable screen sizes differ depending on the types of input signals. While watching a TV broadcast, press **SCREEN SIZE** on the remote control to cycle the picture through Auto, FULL, Dot by Dot, ZOOM, CINEMA, 4:3, WIDE, WIDE 1 and WIDE 2. Freely change the screen size during broadcasts or video from other input sources. Auto is available when receiving HD broadcasts.

The following chart provides information about how the screen appears for each option.

AV Option	Description
Auto	adds side masks or displays the image in full screen when detecting HD pictures containing side masks. See <i>Detect Masks</i> on page 59.
FULL	squeezes 16:9 images
Dot by Dot	matches input signal to the same number of screen pixels (available for 1080i or 1080p signals only)
ZOOM	bars may appear on the top and bottom on some programs that are 16:9 letterbox
CINEMA	bars may appear on the top and bottom on some programs that are 14:9 letterbox (available for SD signals only)
4:3	side bars appear on each side
WIDE	pictures progressively stretch toward each side (available for SD signals only)
WIDE 1	pictures progressively stretch toward each side (available for HD signals only)
WIDE 2	pictures evenly stretch toward each side (available for HD signals only)
PC Option	Description
4:3	fills without altering the input signal aspect ratio
FULL	shows 16:9 screen display

With WIDE 1 or WIDE 2 selected, a High Definition (HD) TV broadcast may crop part of an image or menu. If an image or menu appears cut or runs off the screen, change the option to FULL.

Avoid showing signals that fill only part of the screen. Images that fail to fill the screen may cause temporary or permanent image retention depending on the frequency and duration. For example, an HD broadcast with side masks (4:3 content) causes uneven wear of the plasma cells. If side masks appear around a broadcast, after that program or movie is over, switch to a full screen motion video. This action helps the panel balance wear for the plasma cells and guard against after-image issues. For more information about Masks, refer to "4.3.1 Adjust for Screen Masking (black bars on sides)."

Note: Not all broadcast programs carry alternative screen sizes.

4.2.2 Correct the Picture for an AV or PC Source

Although picture adjustments are to your personal preferences, often the source causes unanticipated image changes. Your flat panel TV offers several adjustment options.

AV Source

Option	Left Arrow	Right Arrow
Contrast	less contrast	more contrast
Brightness	dimmer	brighter
Color	decreased intensity	increased intensity
Tint	purplish skin tones	greenish skin tones
Sharpness	softer definition	crisper definition

PC Source

Option	Left Arrow	Right Arrow
Contrast	less contrast	more contrast
Brightness	dimmer	brighter
Red	weaker color	stronger color
Green	weaker color	stronger color
Blue	weaker color	stronger color

To correct the picture for an AV or a PC source, follow the steps below.

- 1) Access the *Picture* through the *Setup*.
- 2) Select an option to adjust.

AV Source



PC Source



- 3) Select the desired level for that option using the left/right arrows (←/→).



- 4) Repeat the process for any additional adjustments.
- 5) Press **HOME MENU** to exit the menu after all adjustments are complete.

Note: Reset returns all settings to the factory defaults.

4.3 Assign Advanced Picture Functions

Your flat panel TV provides various advanced functions for optimizing the picture quality that go beyond the basic adjustments explained earlier in this manual. This section explores the value offered through Pioneer's PureCinema High Definition (HD) support, top quality blacks, better balanced whites, and overall color improvements.

4.3.1 Adjust for Screen Masking (black bars on sides)

Screen Masks fill areas on both sides of a picture. Some content fails to fill the screen so bars appear on each side of the picture. This section explains how to adjust screen masking.

Detect Masks

Some HD broadcasts transmit in 4:3 content with side masks. Side masks are black bars that appear on the picture's left and right sides. If the flat panel TV's Screen Size is set to Natural during the Auto Size process, gray bars replace the black bars. When the panel is set to Wide-Zoom, the bars are hidden. These responses reduce after-image concerns.

To allow the panel to detect side masks, follow the steps below.

- 1) Access the *Option* through the *Setup*.
- 2) Select *Side Mask* from the Option menu.
- 3) Select *Detection* from the submenu.
- 4) Select *Mode 1* or *Mode 2* to activate Side Mask Detection.
Mode 1 detects only black side masks and Mode 2 detects both black and illustrated side masks. Select Off to deactivate this function.
- 5) Press **HOME MENU** to exit the menu.
- 6) Confirm that the word "AUTO" appears in the InfoBanner.

Video signals can affect the Side Mask Detection function differently. For High Definition broadcasts, if Side Mask Detection is on, the panel automatically detects images containing side masks and shows the picture in full screen. Cycle the screen size to select Auto for video signals without aspect ratio information.

Video content also can affect the Side Mask Detection function. If a detection error occurs when trying to watch HD content, manually change the screen size to the proper setting for the content.

HD Wide Mode

The HD Wide Mode allows selecting the display mode (WIDE 1 or WIDE 2) when detecting side masks that appear in a 4:3 image. This option is available when the Auto Size menu is set to Wide-Zoom and Side Mask Detection to Mode 1 or Mode 2. To allow the HD Wide Mode, follow the steps below.

- 1) Access the *Option* through the *Setup*.
- 2) Select *Side Mask* from the Option menu.
- 3) Select *HD Wide Mode* from the submenu.
- 4) Select *Mode 1* or *Mode 2* to activate HD Wide Mode.
 - *Mode 1: screen mode sets to WIDE 1 when detecting side masks.*
 - *Mode 2: screen mode sets to WIDE 2 when detecting side masks.*
- 5) Press **HOME MENU** to exit the menu.

Lighten Side Masks

If content appears with bars (side masks) on each side of a picture when the screen size is 4:3 and Side Mask Detection is set to Mode 1 or Mode 2, the bars automatically change from black to gray. However, the gray is fairly dark. To change the bars to a lighter shade of gray, follow the steps below.

- 1) Access the *Option* through the *Setup*.
- 2) Select *Side Mask* from the Option menu.
- 3) Select *Brightness Sync.* from the submenu.
- 4) Select the desired parameter.

Parameter	Description
Fixed	sets the same brightness for gray side masks
Auto	adjusts the side mask brightness according to the brightness of screen images

- 5) Press **HOME MENU** to exit the menu.

4.3.2 Select a PureCinema Level for High Quality Image

Pioneer's PureCinema automatically detects and analyses a film-based source (originally encoded at 24 frames/second) then recreates each still film frame for HD picture quality. The function supports both film and text material.

To set the PureCinema level for your HD material, follow the steps below.

- 1) Access the *Picture* through the *Setup*.
- 2) Select *PureCinema* from the submenu.
- 3) Select *Film Mode* or *Text Optimization* depending on the material.
- 4) Select the desired parameter.

Mode	Parameter	Description
Film Mode	Off	deactivates PureCinema
	Standard (not available for input signals 480p, 720p @60 Hz, or 1080p @60 Hz)	automatically detects recorded image data when displaying DVD or high-definition images (e.g., movies) having 24 frames per second for smooth and vivid playback
	Smooth (not available for input signals 1080p @60 Hz)	produces smoother and more vivid moving images
	Advance (not available for input signals 1080p @60 Hz)	converts theatre-quality images to 72 Hz when displaying DVD images (e.g., movies) having 24 frames per second for smooth and vivid playback
Text Optimization	Off	deactivates text optimization
	On	improves subtitle display quality

- 5) Press **HOME MENU** to exit the menu.

Note: Activating the Game Control Pref setting under the Option menu disables the PureCinema setting.

4.4 View in Multi-Screen

The flat panel TV can show multiple screens at the same time; two-screen or picture-in-picture. The pictures may be reversed (in 2-screen and P-in-P) or moved to various locations on the screen (P-in-P).

2-Screen



Picture-in-Picture (P-in-P)

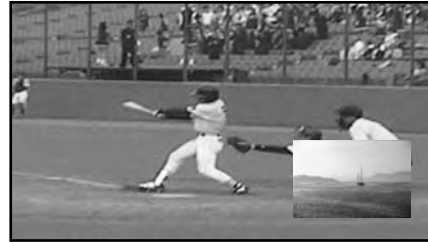

4.4.1 Split/Swap/Shift the Screen

To split the screen so that two channels appear, press the **SPLIT** button on the remote control. Each press of the button cycles the screen through two-screen, picture-in-picture, and single-screen views.

To switch the images between screen sides/locations, press the **SWAP** button.

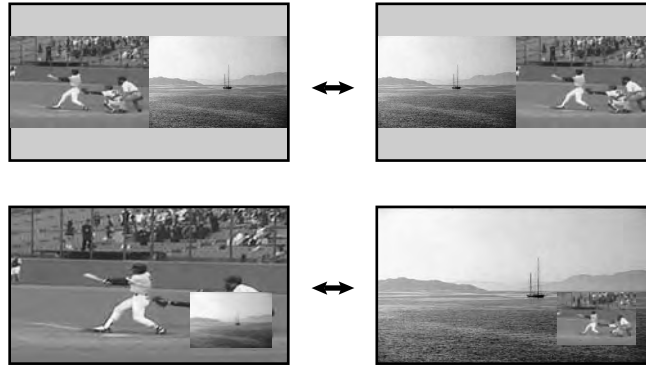

To move the Picture-In-Picture (P-in-P) small image counter-clockwise, press the **SHIFT** button.

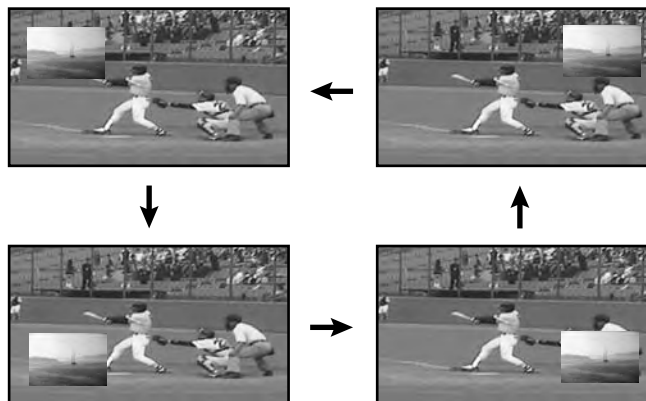

Press SPLIT to cycle through the different multi-screen views.
Press SWAP to switch the position of the two screens.
Press SHIFT to move the position of the small screen counter-clockwise.

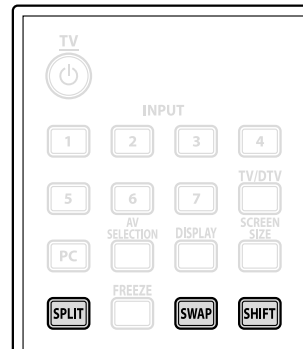

The multi-screen function is unavailable when viewing source from a single input or from two *external* input sources.

Warning: Displaying pictures in multi-screen mode for an extended period may cause an after-image.

To return to a single picture, press **EXIT**.

Another option is to select a multi-screen mode from the TOOLS Menu. To select a multi-screen mode, follow the steps below.

- 1) Press **TOOLS**.
The TOOLS Menu screen appears.
- 2) Select *Split*, *Swap* or *Shift* from the menu.
*Use the arrow buttons to highlight an option (then press **ENTER** if you select *Swap*).*
- 3) Select a mode.
*Select *Off*, *2-screen* or *P-in-P* for the *Split* mode. The selected mode is displayed in the center of the TOOLS Menu.*

4.5 Freeze the Picture

During fast-action sequences or detailed pictures, try capturing the image with the FREEZE option. FREEZE allows you to better understand the action or picture details if desired. To freeze a picture from a TV broadcast or movie, follow the steps below.

- 1) Press **FREEZE** to create a still image picture (copy) of the currently showing image.
The copy appears to the right of the still-moving video sequence thus splitting the screen.
 - 2) Press **FREEZE** again to release the image.
The frozen image disappears, returning the picture to a single screen with the video sequence still in progress.
- With the screen split, an image cannot be frozen.



A warning message appears if you attempt to use this function when there is already a frozen image on screen. If an image is left frozen on the screen, the panel automatically releases the image after five minutes.

Note: Using FREEZE for an extended period may cause an after-image.

4.6 Use the Banner Feature

When tuning in a TV channel or an input signal changes, any available information appears on the screen if the signal carries information about the program (See InfoBanner below). Pressing **DISPLAY** causes the InfoBanner (additional) to appear. Press **EXIT** or **DISPLAY** again to hide the banner.

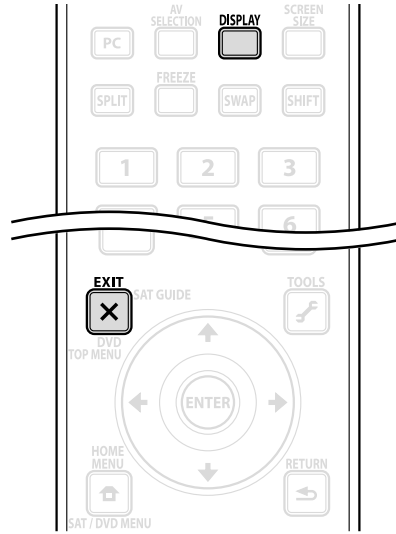

InfoBanner

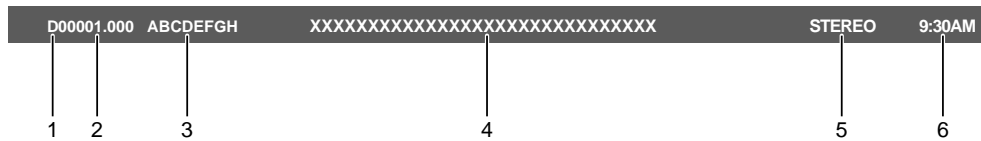

InfoBanner (additional)

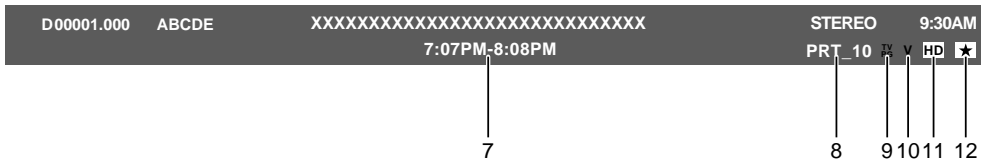

- 1 - Broadcast signal (Digital/Analog)
- 2 - Channel number
- 3 - Station name
- 4 - Program title
- 5 - Sound multiplex information
- 6 - Current time
- 7 - Program time schedule
- 8 - Parental Control information
- 9 - Parental icon
- 10 - Parental name
- 11 - Signal information (HD/SD)
- 12 - Favorite icon

A separate banner also appears at the bottom of the screen showing the AV Selection mode (bottom left) and screen size (bottom right).

The above information is only appears if it is included in the broadcast signal. During multi-screen mode, the banner appears in both main and sub screens.

4.7 Select Alternatives for/to Sound

There are four sound alternatives for your flat panel TV; CC, MTS, SAP, and Sound Effect. This section defines each of these alternatives then explains how/when to use.

4.7.1 Activate Closed Captioning (CC)

Your flat panel TV is equipped with an internal closed caption (CC) decoder. CC allows conversations, narration, and sound effects in TV programs and home videos to appear as subtitles on the screen. For digital channels, some parameters can be changed such as the text font and color. However, not all programs/videos offer closed caption. Please look for the "CC" symbol to confirm that the channel or program provides closed captioning.

To activate closed captioning when available, follow the steps below.

- 1) Access the *System Setup* through the *Setup*.
- 2) Select *Closed Captions* from the System Setup menu.
- 3) Select *Status* from the submenu.
- 4) Select an option.

Parameter	Description
Off	does not show closed captioning (default)
On	shows closed captioning when available
On If Mute	shows closed captions only while sound is muted

- 5) Press **HOME MENU** to exit the menu.

Types of Closed Caption

Broadcast TV offers different types of closed captioning. Your flat panel TV provides support for the recognized types on Analog programming as well as Digital signals that carry analog closed captions.

- CC 1, CC 2, CC 3, or CC 4: provides subtitles with a full view of the picture
- Text 1, Text 2, Text 3, or Text 4: superimposes other information (e.g. weather) that is independent of the TV program in progress

To change the closed caption type from the default CC 1, follow the steps below.

- 1) Access the *System Setup* through the *Setup*.
- 2) Select *Closed Captions* from the System Setup menu.
- 3) Select *Analog Settings* from the submenu.
- 4) Select the desired closed caption.

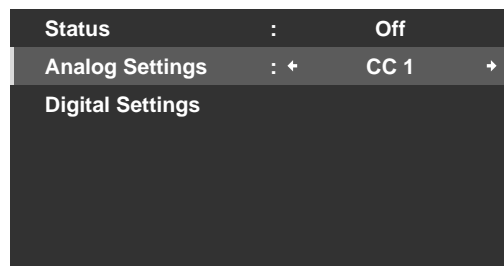

- 5) Press **HOME MENU** to exit the menu.

Closed Caption for Digital Programs

There are six different closed caption options for digital programming, called Service levels. The Primary Caption Service is on Service 1 and the Secondary Language Service is on Service 2. More information about these offerings is found later in this chapter.

To change the digital closed caption from the default Service 1, follow the steps below.

- 1) Access the *System Setup* through the *Setup*.
- 2) Select *Closed Captions* from the System Setup menu.
- 3) Select *Digital Settings* from the submenu.
- 4) Select *Digital Service*.
- 5) Select the desired closed caption service level (←/→).

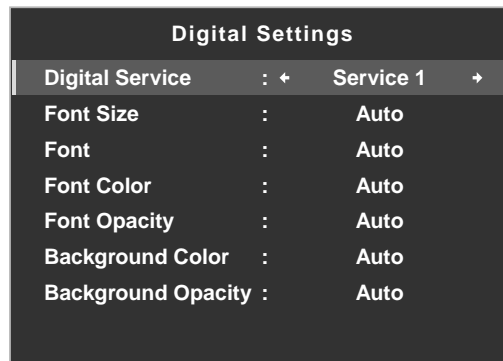

- 6) Press **HOME MENU** to exit the menu.

To change the appearance of closed captioning on a digital program, follow the steps below.

- 1) Access the *System Setup* through the *Setup*.
- 2) Select *Closed Captions* from the System Setup menu.
- 3) Select *Digital Settings* from the submenu.
- 4) Select an option to change.
- 5) Select the desired parameter for that option.
The default parameter for each option is Auto.

Option	Description
Font Size	Auto, Large, Standard, Small
Font ¹	Auto, Font 1, Font 2, Font 3, Font 4, Font 5, Font 6, Font 7
Font Color	Auto, Black, White, Red, Green, Blue, Yellow, Magenta, Cyan
Font Opacity	Auto, Solid, Transparent, Translucent, Flashing
Background Color	Auto, Black, White, Red, Green, Blue, Yellow, Magenta, Cyan
Background Opacity	Auto, Solid, Transparent, Translucent

¹ Font 1 (monospaced with serifs)/ Font 2 (proportionally spaced with serifs)/ Font 3 (monospaced without serifs)/ Font 4 (proportionally spaced without serifs)/ Font 5 (casual font)/ Font 6 (cursive font)/ Font 7 (small capitals font)

- 6) Press **HOME MENU** to exit the menu.

4.7.2 Switch Languages Using MTS

Multi-channel Television Sound (MTS) allows switching the audible language if it is available for that program. Available languages differ depending on the current broadcast.

When watching a digital TV program that provides multi language services, follow the steps below.

- 1) Press **TOOLS** on the remote control.
- 2) Select *MTS* from the TOOLS Menu.
- 3) Select *English, Français* or *Español*.

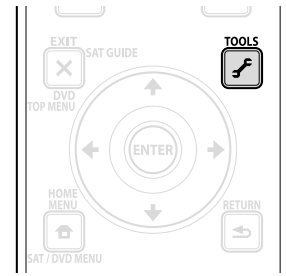

A digital TV program without sound or language information causes "N/A" to appear on the screen. For languages other than English, French, or Spanish, the word "Others" appears instead. If the selected language is available when the channel or program is changed, that language is heard.

4.7.3 Select SAP

When watching TV programs on the VHF/UHF frequencies or from analog cable TV channels, the **TOOLS** button can activate Stereo Sound and/or Secondary Audio Programs (SAP) if available.

To select Stereo/SAP options, follow the steps below.

- 1) Press **TOOLS**.
- 2) Select *MTS* from the TOOLS Menu.
- 3) Select *STEREO, SAP* or *MONO*.

The chart below breaks down the Stereo/SAP options.

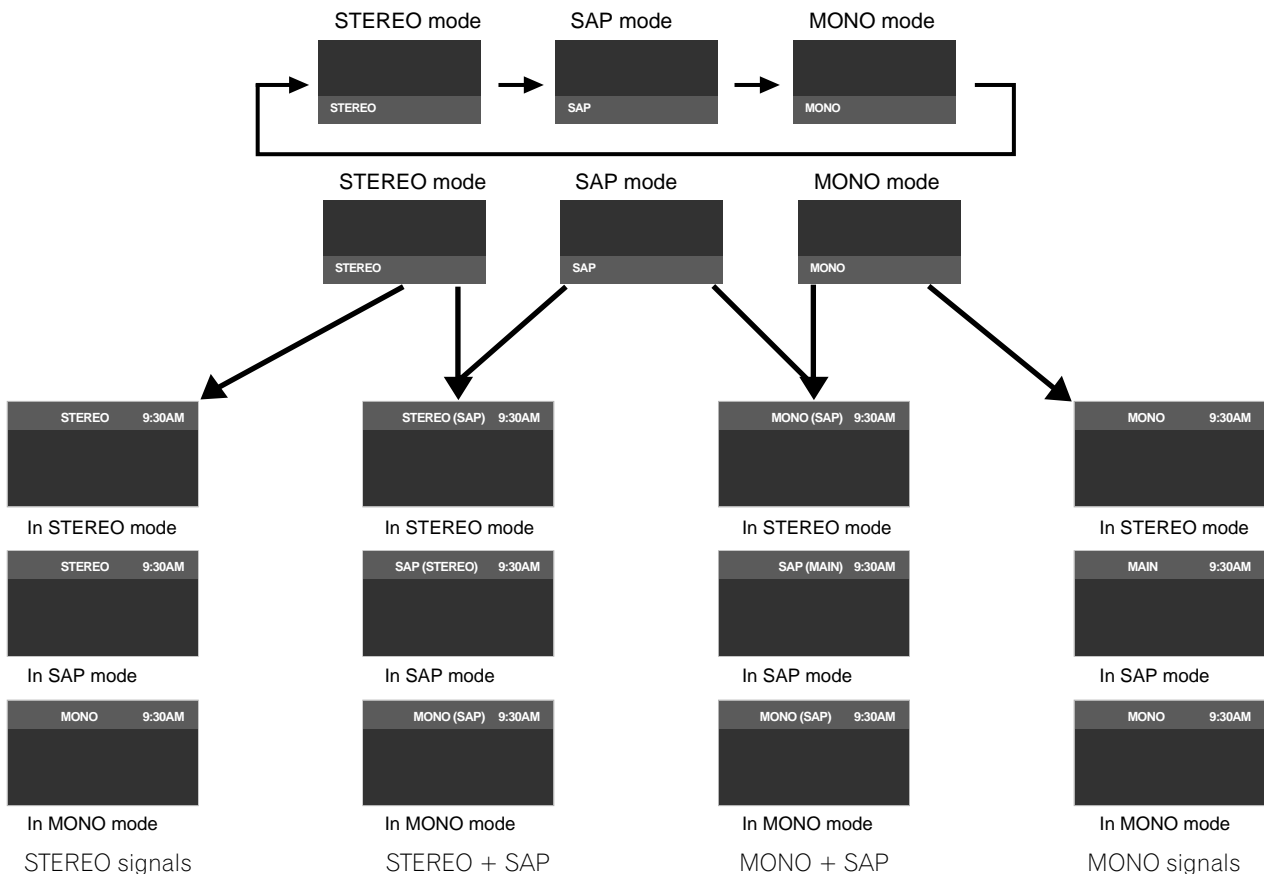

When stereo sound is difficult to hear, manually switch to MONO for clearer sound. The panel's sound remains in mono even if the system receives a stereo broadcast. Reselect STEREO to hear broadcasts in stereo where available.

Selecting MTS while the input source is INPUT 1 to INPUT 7 or a PC does not change the type of sound. In this case, the video source determines the sound.

4.7.4 Apply Sound Effect Settings

Your flat panel TV offers four sound effects: SRS FOCUS, SRS, SRS TruBass and SRS Definition.

- SRS FOCUS™ moves sound source direction vertically and makes sound and voice clearly audible
- SRS® effortlessly produces a three-dimensional sound field
- SRS TruBass® produces a clear, rich bass tone
- SRS Definition® improves midrange quality and clarifies voice and instrument sound

To activate one or more of the sound effects, follow the directions below.

- 1) Access the *Sound* through the *Setup*.
- 2) Select *Sound Effect* from the Sound menu.
- 3) Select a sound effect option.
(*SRS FOCUS, SRS, SRS TruBass, SRS Definition*)
- 4) Select *Low* (moderate), *Mid* (standard), *High* (enhanced) or *Off* for that option.
- 5) Press **HOME MENU** to exit the menu.

Note: How a Sound Effect changes the Audio depends on the signal.



(*SRS WOW HD™*) indicates that SRS FOCUS, SRS, SRS TruBass and SRS Definition are on.

4.7.5 Use Auto Volume Control (AVC)

Auto Volume Control, or AVC, reduces sudden volume change and compensates source sound level.

To select this option, follow the procedure below.

- 1) Access the *Sound* through the *Setup*.
- 2) Select *AVC* from the Sound menu.
- 3) Select *On* (or *Off*).
- 4) Press **HOME MENU** to exit the menu.

4.8 Manage the Power

Your flat panel TV is energy efficient but includes functions to save additional power. In an earlier section entitled "3.6 Smart Starts for New Owners", you were told how to activate the Energy Save feature. This section provides more advanced functions to save power and to extend the panel life.

AV/PC Source - Picture Off

To save energy and extend the life of your flat panel TV, have the screen turn Off. To deactivate the screen, follow the steps below.

- 1) Press **TOOLS** on the remote control.
- 2) Select *Picture Off* from the TOOLS Menu.
- 3) Press **ENTER**.
The screen display turns Off.
*To restore the screen display, press any buttons other than **VOL +/-** and **MUTING**.*

Note: The Picture Off setting is not memorized by the system.

AV Source - No Signal

To save energy and extend the life of your flat panel TV, the panel can enter Standby automatically if the AV source signal fails for 15 consecutive minutes. At five minutes before and at every minute after that, a warning message appears on the screen. When the final minute elapses, the panel switches to Standby.

To have the panel switch to Standby when an AV source signal fails, follow the steps below.

- 1) Access the *Power Control* through the *Setup*.
- 2) Select *No Signal off* from the Power Control menu.
- 3) Select *Enable* to activate the AV Signal off power function.
- 4) Press **HOME MENU** to exit the menu.

Note: The flat panel TV may switch to Standby when there is noise (signal interference) at the end of a broadcast schedule (channel goes off-air).

AV Source - Non-Operational

To save energy and extend the life of your flat panel TV, the panel can enter Standby automatically if there are no commands from the AV source for three consecutive hours. At five minutes before and at every minute after that, a warning message appears on the screen. When the final minute elapses, the panel switches to Standby.

For the panel to enter Standby automatically when there are no commands from the AV source, follow the steps below.

- 1) Access the *Power Control* through the *Setup*.
- 2) Select *No Operation off* from the Power Control menu.
- 3) Select *Enable* from the No Operation off menu.
- 4) Press **HOME MENU** to exit the menu.

PC Source -Power Management

When receiving signals from a PC, the panel can enter Standby automatically if the signal fails. Follow the steps below to activate this function.

- 1) Access the *Power Control* through the *Setup*.
- 2) Select *Power Management* from the Power Control menu.
- 3) Select an option from the submenu.

Option	Description
Off	no power management (default)
On	panel enters Standby when no signal is received from the PC for eight minutes ; using the PC has no effect on the panel

*Note: Pressing the remote's TV  or the panel's **STANDBY/ON** reactivates the flat panel TV.*

- 4) Press **HOME MENU** to exit the menu.

These power management options are unavailable when a PC is connected to the panel through the HDMI port/terminal.

5 Use Other Equipment With Your Flat Panel TV

Although earlier sections have mentioned other equipment for playing back video, this section provides control and operation information for specific types of equipment.

5.1 Program the Remote Control to Operate Other Equipment

To operate other equipment or devices through your flat panel TV, program the panel's remote control with the equipment's manufacturing code. A manufacturing code is a series of numbers that identify the type of device and the brand. These codes are available in the section entitled "8.2 Manufacturer Codes to Program into the Remote Control" in Appendix 8.2 of this manual.

5.1.1 Assign a Manufacturing Code to the Remote Control

To assign a preset Manufacturing code to the panel's remote control, follow the directions below. (For Manufacturing codes, refer to "8.2 Manufacturer Codes to Program into the Remote Control")

- 1) Press **SELECT** to choose the device to program.
- 2) Press **EDIT** and **1** at the same time.
The selected mode indicator flashes when the remote control is ready to be programmed.
- 3) Use the number buttons to enter a manufacturer code.
When the indicator turns off, the code has been programmed into the remote control.

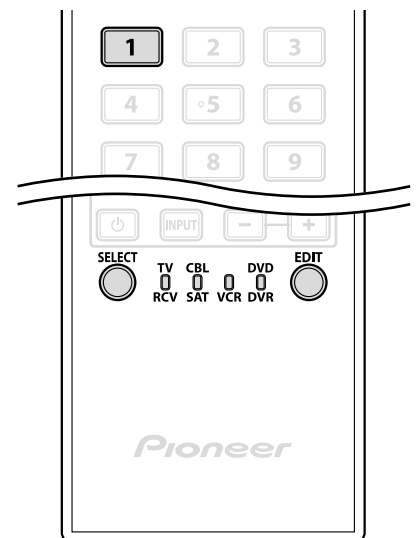

5.1.2 Issue a Library Search for a Manufacturer Code

If the code for a particular device is unknown, cycle through the available codes for a similar unit then sample some functions for that code.

To find the code that properly operates the unit, follow the steps below using different codes to find the best match.

- 1) Press **SELECT** to choose the device to program.
- 2) Press **EDIT** and **3** at the same time.
The selected mode indicator flashes when the remote control is ready to search the code library.
- 3) Sample the code using a SOURCE POWER, PLAY, 1 or CH+ command.
- 4) Use the up/down arrow (↑/↓) buttons to advance to the next code if the code fails to control the device.
Another option is to return to the previous code and repeat Step 3.
- 5) Press **ENTER** to lock in the code that properly operates the device.
All the available buttons for the selected mode are added when the mode indicator flashes on for one second. The remote control then returns to normal operation.

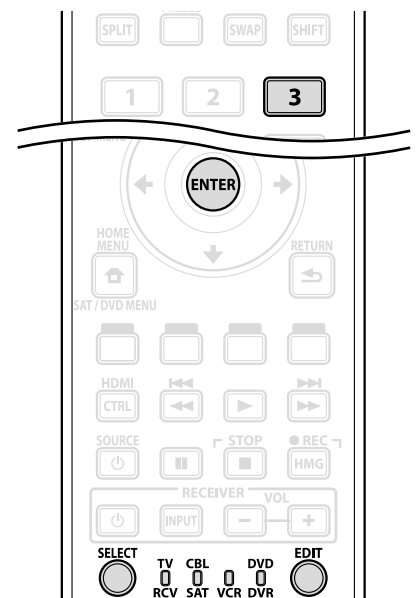

5.1.5 Control a Cable (CBL) or Satellite (SAT) System

When Mode is set to CBL/SAT, a cable converter uses the buttons **1, 6, 7, 8,** and **9** while satellite tuners use the buttons **1** to **8**. However, the panel only recognizes a single system (cable or satellite) at a time.

- **1** Number buttons
(press to enter a channel number)
- **2** SAT GUIDE
(displays the satellite broadcasting guide screen)
- **3** ENTER
(Enter activates the selected function)
(arrows to select from SAT GUIDE or MENU screens)
- **4** SAT MENU
(displays the satellite broadcasting menu screen)
- **5** SOURCE
(turns the equipment power on and off)
- **6** CH ENTER*
(enters the selected channel with the direct channel selection buttons)
- **7** CH RETURN*
(press buttons that correspond to a channel)
- **8** CH +/-
(selects a higher or lower channel)
- **9** RETURN
(restores the immediately previous screen)

* Some cable converter manufacturers do not preset CH ENTER and CH RETURN.

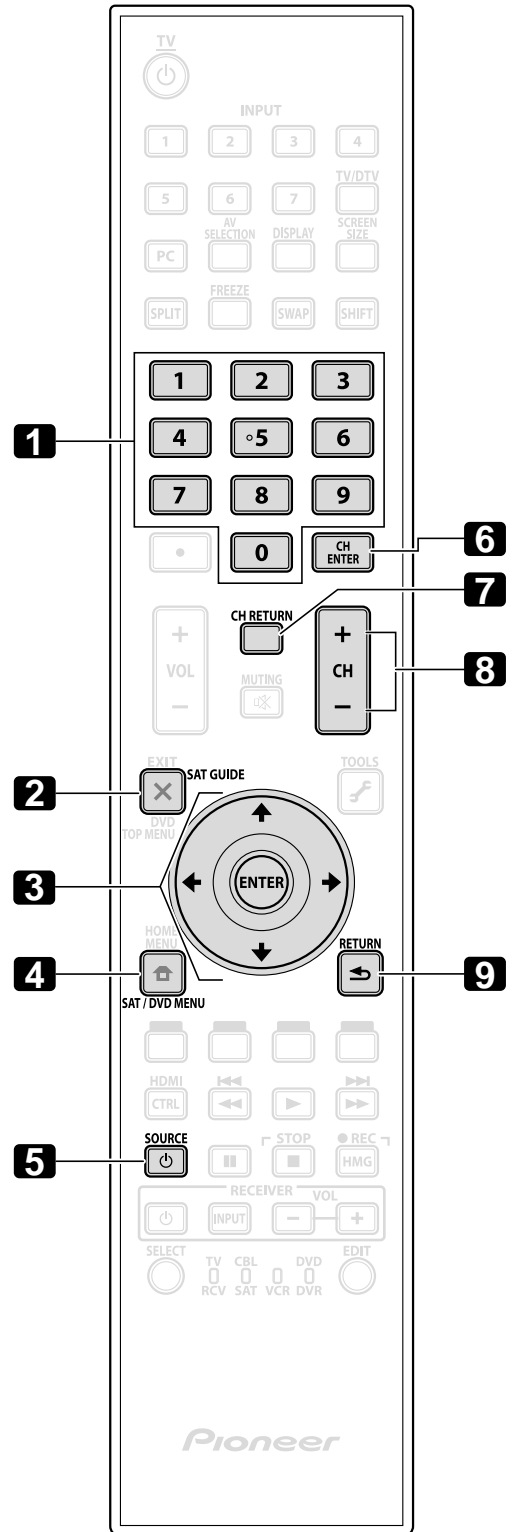

5.1.6 Control a Video Cassette Recorder (VCR)

When Mode is set to VCR, verify that the proper Input is selected (INPUT 1 to INPUT 7) then use **1** to **8** to control the device.

- **1** REWInd
(rewinds the VCR tape and allows searches)
- **2** PAUSE/STILL
(pauses playback and displays still images)
- **3** SOURCE
(turns the VCR's power on and off)
- **4** CH +/-
(selects a higher or lower channel)
- **5** PLAY
(selects playback)
- **6** FF
(advances the VCR tape and allows searches)
- **7** STOP
(halts VCR tape transport)
- **8** RECord
(begins recording)

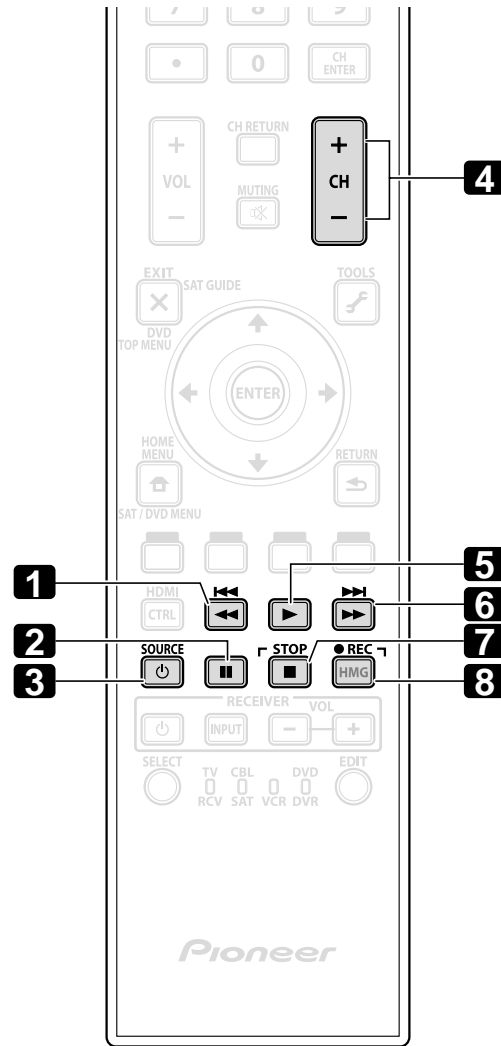

5.1.7 Control a DVD Player/DVR Recorder/BD Player

When Mode is set to DVD/DVR, the remote control can operate DVD players, DVD recorders or BD players connected to the flat panel TV. Verify that the proper Input is selected for the device then use **1** to **14** to control it.

Note: Equipment from other manufacturers (DVD players, DVD recorders, BD players, and HD-DVD players) can also be operated using the remote control if the remote is preset for the device(s).

- **1** DVD TOP MENU
(displays the top menu on the DVD)
- **2** ENTER
(Enter activates the selected function)
(arrows to select from SAT GUIDE or MENU screens)
- **3** DVD MENU
(displays the DVD menu)
- **4** Red/Green/Blue/Yellow (BD only)
(Controls a BD-J application)
- **5** REVERSE SCAN/CHAPTER SEARCH
(press once quickly to go to beginning of current chapter; press again to go back to the beginning of the previous chapter; continue pressing to go backward)
- **6** PAUSE/STILL
(Pauses playback and displays still image)
- **7** SOURCE
(turns the equipment power on or off)
- **8** CH +/- (DVD Recorder only)
(selects a higher or lower channel)
- **9** TOOLS
(assigns the code for a Pioneer BD player)
- **10** RETURN
(restores the immediately previous screen)
- **11** PLAY
(selects playback)
- **12** FORWARD SCAN/CHAPTER SEARCH
(press once quickly to go to beginning of next chapter; press again to advance to beginning of next chapter; continue pressing for fast forward)
- **13** STOP
(halts DVD playback, some DVD players/recorders open the disc tray if this button is pressed twice)
- **14** RECord (DVD Recorder only)
(begins recording)

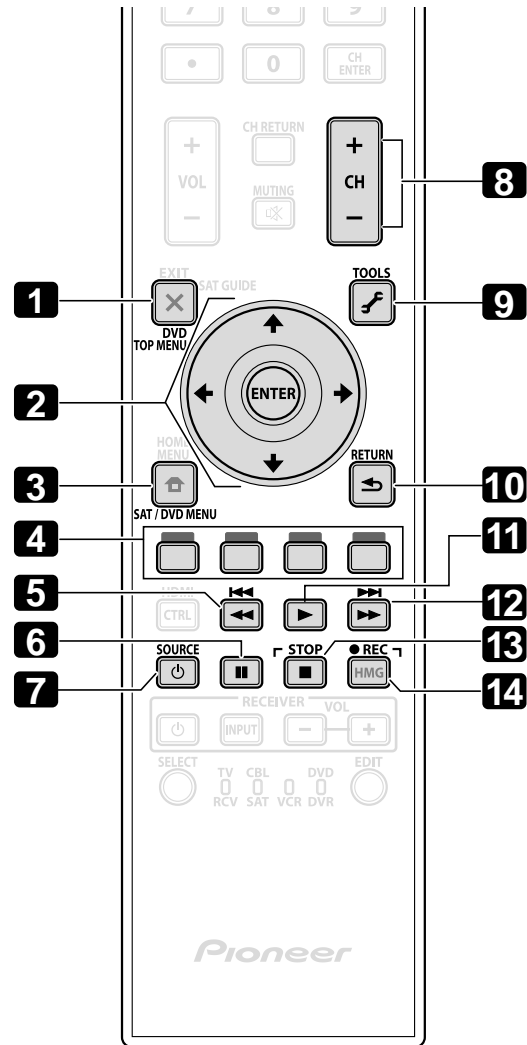

13 & **14** STOP RECord (DVD Recorder only)
(press and hold ● then press ■ to stop recording - applies to Pioneer DVD recorders only)

5.2 Use HDMI Inputs

High Definition Multimedia Interface (HDMI) is a communication method commonly used by digital and/or high definition equipment. Your flat panel TV's INPUT 4, INPUT 5, INPUT 6, INPUT 7 are HDMI terminals for incoming digital video and audio signals. The flat panel TV supports HDMI Control functions so that when a piece of equipment is connected to the panel, it can control the equipment. To use an HDMI terminal, specify the types of video and audio signals being sent from the connected equipment. For the signal types, see the operating manual(s) that came with the equipment.

One of the benefits of using your flat panel TV to control other equipment is the support of Deep Color. Deep Color is the color depth that describes the number of bits used to represent the color of a single pixel in a bitmapped image. Besides the conventional RGB/YCbCr16bit/20bit/24bit signals, the flat panel TV also supports RGB/YCbCr30bit/36bit signals. This enables finer color reproduction when a device that supports Deep Color signals (HDMI1.3 Deep Color) is connected to the panel. The color depth appears on the InfoBanner if a program supports Deep Color.

The flat panel TV supports the following Video signals:

Supported Video Signals	Supported PC Signals
<ul style="list-style-type: none"> • 1920 x 1080p@60 Hz • 1920 x 1080p@24 Hz • 1920 x 1080i@59.94 Hz/60 Hz • 1280 x 720p@59.94 Hz/60 Hz • 720 x 480p@59.94 Hz/60 Hz • 720 (1440) x 480i@59.94 Hz/60 Hz 	<ul style="list-style-type: none"> • 1280 x 1024 (SXGA) 60 Hz • 1360 x 768 (Wide - XGA) 60 Hz • 1024 x 768 (XGA) 60 Hz • 800 x 600 (SVGA) 60 Hz • 640 x 480 (VGA) 60 Hz

Note: It may take a short period for the image to appear on the other equipment, depending on the type of device.

The flat panel TV supports the following Audio signals:

- Linear PCM (STEREO 2ch)
- Sampling frequency: 32 kHz, 44.1 kHz, 48 kHz

When connecting a PC to one of the panel's HDMI inputs, use an HDMI-compliant PC or video card. Using DVI output from the PC to the flat panel TV may cause the sound or picture to fail or seem distorted. If a DVI output is your only option then contact the PC manufacturer for assistance.

5.2.1 Specify the HDMI Input Type

To select a signal type, follow the steps below.

- 1) Select the Input for the connected equipment.

*Press the **INPUT** button (remote control or panel) until the correct input is showing (INPUT 4, INPUT 5, INPUT 6, or INPUT 7).*

Note: For INPUT 4 and INPUT 5, add Audio cables to support analog signals.

- 2) Access the *Option* through the *Setup*.
- 3) Select *HDMI Input* from the Option menu.
- 4) Select *Signal Type* from the submenu.
- 5) Select the appropriate option.

Option	Description
Video	use except when a PC is connected (default)
PC	when a PC is connected to HDMI input terminal

- 6) Press **HOME MENU** to exit the menu.

In Video mode, the image is over-scanned (enlarged) but the panel automatically switches to PC when receiving computer signals. In PC mode, the image displays in full size for optimum image quality.

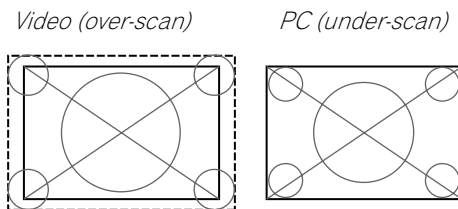

5.2.2 Specify a Digital HDMI Signal Type

For the necessary digital video signal type, check the operating manual that came with the other equipment.

To assign the type of digital signal, follow the steps below.

- 1) Access the *Option* through the *Setup*.
- 2) Select *HDMI Input* from the Option menu.
- 3) Select *Video* from the submenu.
- 4) Select the type of digital video signal recommended for the attached device.

Type	Description
Auto	automatically identifies input digital signals (default)
Color-1	Digital Component Video signals (4:2:2) locked
Color-2	Digital Component Video signals (4:4:4) locked
Color-3	Digital RGB signals (16 to 235) locked
Color-4	Digital RGB signals (0 to 255) locked

- 5) Press **HOME MENU** to exit the menu.

If an image fails to appear, specify another digital video signal type. Type parameters other than Auto need to be checked for natural colorings.

5.2.3 Specify an Audio HDMI Signal Type

For the necessary audio signal type, check the operating manual that came with the other equipment. When using INPUT 4 or INPUT 5 for HDMI, select the terminal for the desired input source.

To specify the audio type, follow the steps below.

- 1) Access the *Option* through the *Setup*.
- 2) Select *HDMI Input* from the Option menu.
- 3) Select *Audio* from the submenu.
- 4) Select the type of audio signal recommended for the attached device.

Type	Description
Auto	automatically identifies input audio signals (default)
Digital	accepts digital audio signals
Analog	accepts analog audio signals

- 5) Press **HOME MENU** to exit the menu.

If there is no sound, specify another audio signal type. Depending on the type of equipment, sound output may require analog audio cables in addition to the HDMI connection(s).

Note: When signals come through the HDMI terminals, no signals are output from the DIGITAL OUT terminal if they are copy guarded.

5.3 Control Equipment with the Panel's Remote Through HDMI

Your flat panel TV's remote can control other equipment such as a recorder, player, or AV system through the HDMI Control functions. The HDMI Control functions include playback of content using an on-screen control panel. However, not all device operations may be available through HDMI control. For details, see the charts below.

Control Function	Controlled Equipment	Function Description
Playback of content	Recorder Player	Pressing PLAY on a connected device automatically selects the source and begins playback.
On-screen control	Recorder Player	Recorder/player operation can be controlled on-screen or with the panel's remote (play, stop, fast forward/reverse, etc.).
Display Language Setup	Recorder Player	Information on the display menu language transfers to the recorder or player connected to the flat panel TV. For details, see the operation manual that came with the recorder or player.
AV system control	AV system	Receiver/amplifier operation can also be controlled with the panel's remote, (volume, surround mode and input selection of the HDMI terminal).
Power ON	Recorder Player	The flat panel TV can be turned On when a connected recorder(s) or player(s) is turned On and images are input to the flat panel TV.
Power OFF	Recorder Player AV system	The connected device(s) can be turned Off when the flat panel TV is turned Off.

*Notes: The KURO LINK function name used on the web and in catalogs is referred to as HDMI Control in the operating instructions and on the product.
Except for Power Off and Display Language Setup functions, only a single HDMI terminal may be active at a time.*

The flat panel TV's remote can control a maximum of two (2) recorders, two (2) playback devices, and one (1) AV system at a time.

To select and use the various HDMI Control functions for a connected Pioneer AV system, recorder, or player, use the panel's HDMI Control menu.

To access the menu, follow the steps below.

- 1) Press **HOME MENU**.
- 2) Select *HDMI Control* from the main menu.
Use the arrow buttons to highlight an option then press **ENTER**.

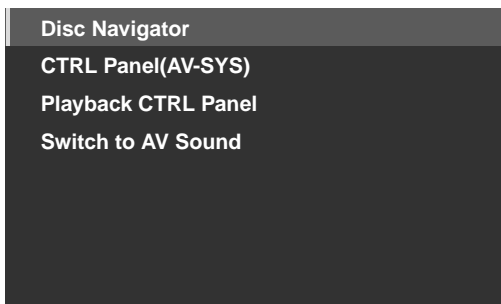

*Note: Pressing **HDMI CTRL** on the remote also causes the HDMI Control menu to open.*

Option	Description
Disc Navigator	displays a title list of connected recorder or player
CTRL Panel (AV-SYS)	displays the control panel for connected AV system
Playback CTRL Panel	displays the control panel for connected recorder or player
Switch to AV Sound/ (Switch to TV Sound)	switches between the flat panel TV screen and the connected AV system for sound output

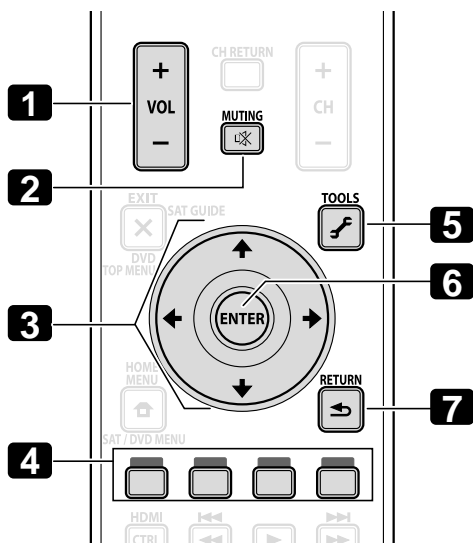

Use the following buttons to control functions such as the disc navigator on a recorder or player.

- **1** VOL +/-
(adjusts the volume for an AV system)
- **2** MUTING
(turns off the sound while the video continues to play)
- **3** Arrow buttons
(navigates the menu screen)
- **4** Color buttons (Red, Green, Blue, Yellow)
(controls a BD player)
- **5** TOOLS
(assigns the code for a Pioneer BD player)
- **6** ENTER
(activates the selected function)
- **7** RETURN
(returns to the previous menu screen)

To connect a device for HDMI Control, follow the steps below.

- 1) Turn on the flat panel TV and all other equipment.
- 2) Confirm that the panel's Input Setting for HDMI Control Setting options comply with directions in the operating instructions for the other device(s).
- 3) Confirm that the other equipment is set for HDMI Control.
- 4) Check that the audio and video are playing back properly from the equipment connected to the HDMI terminal(s).
- 5) Turn Off the flat panel TV.
- 6) Pause for a few seconds before turning the power back on.
- 7) Verify that all equipment is functioning properly.

To select the device to control via HDMI Control, follow the steps below.

- 1) Access the *Option* through the *Setup*.
- 2) Select *HDMI Control Setting* from the Option menu.
- 3) Select *Input Setting* from the submenu.

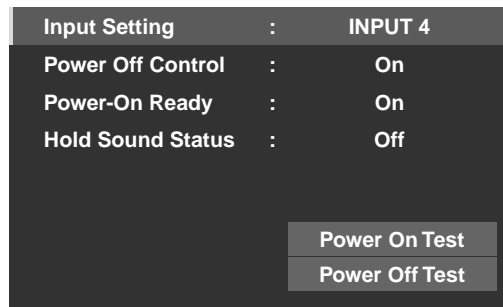

- 4) Select the desired Input (INPUT 4, INPUT 5, INPUT 6, or INPUT 7).
- 5) Press **HOME MENU** to exit the menu.

If operating an HDMI supported device using an HDMI port other than the terminal selected in Input Setting, the system malfunctions. When connecting to an HDMI terminal other than that selected in Input Setting, the equipment settings should block HDMI Control functions. The HDMI Control menu is not selectable when the option Input Setting under the HDMI Control Setting menu is set to Off.

The control menu changes to suit the type of HDMI-compatible equipment. When adding, changing, or removing equipment from HDMI Control, refer to the sections below for installation notes and the supported commands.

5.3.1 Control an AV System

When adding an AV System, connect the unit between the panel and any recorders and/or players. To function properly, an Audio/Video system should support the HDMI Control functions between the panel and any other connected equipment.

If the AV system does not support HDMI Control but the other equipment (player/recorder) accepts this type of control than connect the AV System through the panel's DIGITAL OUT using an optical digital cable and AUDIO OUT using an AV cable (commercially available). The other equipment connects to the HDMI port using an HDMI compliant cable. Signals input from the HDMI are not output from DIGITAL OUT.

During playback, use the remote control's up/down arrows (↑/↓) to cycle through the surround sound options. Use the left/right arrows (←/→) to change the input. To resume playback, return to the HDMI Control menu then select the function again.

AV Systems

- 1 Cycles the surround mode in sequence
- 2 Switches the input source in reverse order
- 3 Switches the surround mode in reverse order
- 4 Closes the screen to return to HDMI Control menu
- 5 Lists the connected equipment (model number)
- 6 Switches the input source in sequence
- 7 Reserved/Void

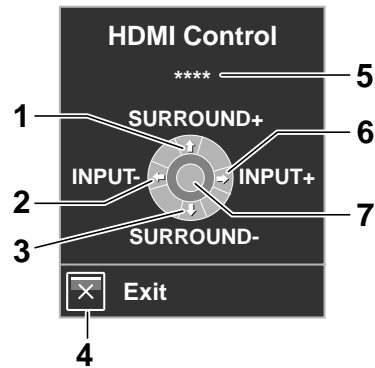

5.3.2 Control a Recorder

Press **ENTER** to start playback or press **HDMI CONTROL** to return to the menu. This process also applies to Players. Refer to the chart below for available commands.

Recorders

- 1 Skips commercials
- 2 Fast reverse
- 3 Stops playback
- 4 Closes the screen to return to HDMI Control menu
- 5 Lists the connected equipment (model number)
- 6 Fast forward
- 7 Starts playback

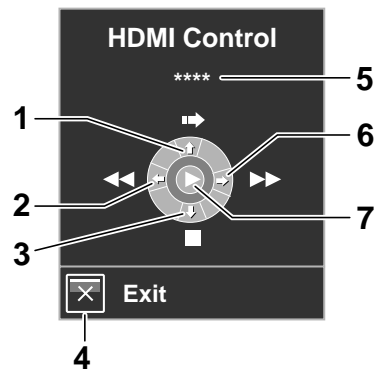

Note: You can also use ► (Play), ■ (Stop), || (Pause), ►► (Fast Forward) and ◀◀ (Fast Reverse) on the remote control to conduct the same operations as the control menu buttons.

5.3.3 Control a Player

Press **ENTER** to start playback or press **HDMI CONTROL** to return to the menu. This process also applies to Recorders. Refer to the chart below for available commands.

Players

- 1 Displays the DVD/Blu-ray disc menu on the player
- 2 Fast reverse
- 3 Stops playback
- 4 Closes the screen to return to HDMI Control menu
- 5 Lists the connected equipment (model number)
- 6 Fast forward
- 7 Starts playback

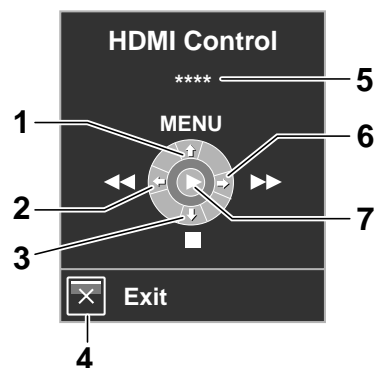

Note: You can also use ► (Play), ■ (Stop), || (Pause), ►► (Fast Forward) and ◀◀ (Fast Reverse) on the remote control to conduct the same operations as the control menu buttons.

5.3.4 Add an AV Amp or a BD Player

To add an AV amp and/or a BD Player, refer to the appropriate cabling diagram below.

AV Amp & BD Player

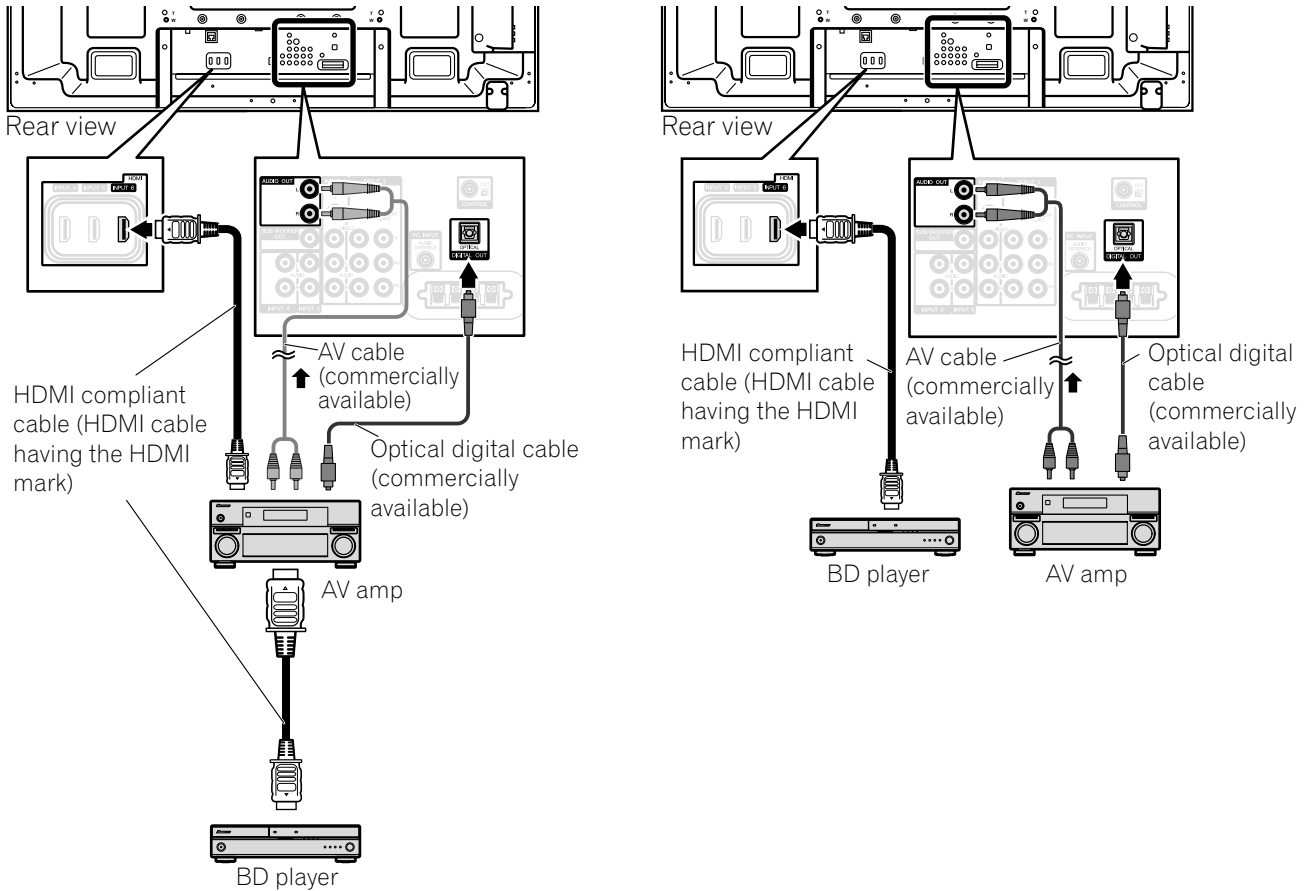

BD Player only

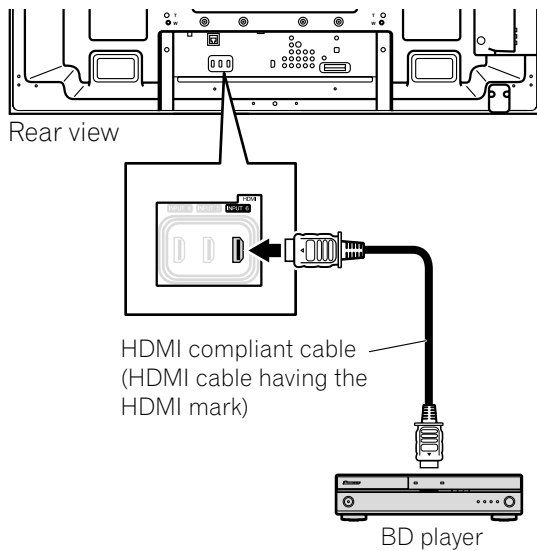

5.4 Specific HDMI Control Commands

When using HDMI equipment with your flat panel TV, some options include when to power the panel and ways to turn other devices or features On and Off. This section provides steps for commonly desirable setting changes.

5.4.1 Play Source Sound Using an HDMI Command

When sound is coming from a Pioneer AV System through the flat panel TV, placing the panel in Standby causes the sound to stop. To have the sound continue when the flat panel TV turns On, follow the steps below.

- 1) Access the *Option* through the *Setup*.
- 2) Select *HDMI Control Setting* from the Option menu.
- 3) Select *Hold Sound Status* from the submenu.
- 4) Select *On* to allow sound from an AV System to play when the panel turns On.
- 5) Press **HOME MENU** to exit the menu.

Note: To have the sound continue when the flat panel TV turns On, confirm that the Switch to TV Sound option appears on the HDMI Control menu before turning the panel Off (see page 77).

5.4.2 Turn OFF the Power With an HDMI Command

The "Power Off Control" function is valid for the devices connected to any of the panel's HDMI ports. To power off a connected device when the flat panel TV is turned Off, follow the steps below.

- 1) Access the *Option* through the *Setup*.
- 2) Select *HDMI Control Setting* from the Option menu.
- 3) Select *Power Off Control* from the submenu.
- 4) Select *On* to allow the panel to power off the connected equipment.
- 5) Press **HOME MENU** to exit the menu.

5.4.3 Turn ON the Power With an HDMI Command

The panel ships from the factory with the Power On command activated. If this feature is turned off in error, it can be reactivated. To power on the flat panel TV automatically when a connected Pioneer recorder or player is turned On and images are sent to the panel, follow the steps below.

- 1) Access the *Option* through the *Setup*.
- 2) Select *HDMI Control Setting* from the Option menu.
- 3) Select *Power-On Ready* from the submenu.
- 4) Select *On* to have another device power-on the panel.
- 5) Press **HOME MENU** to exit the menu.

5.4.4 Test the Power Control (On/Off)

Your flat panel TV provides an HDMI control option to test equipment power when it is connected to the panel's HDMI ports and it has been properly assigned to an Input.

To confirm that the Power On/Off control function is working, follow the steps below.

- 1) Access the *Option* through the *Setup*.
- 2) Select *HDMI Control Setting* from the Option menu.
- 3) Select a test option (*Power On Test* or *Power Off Test*) from the submenu.
A list containing all HDMI connected equipment appears.
- 4) Select a piece of equipment from the list.
- 5) Repeat this process to test other equipment from the list.
- 6) Press **HOME MENU** to exit the menu when all testing is complete.

If the Power On/Off Test fails, check the connection points and the settings.

5.5 Connect a Game Console or Camcorder

Your flat panel TV supplies direct connections for a game console, camcorder, or other Audio/Visual (AV) equipment through INPUT 3. To watch an image coming from a game console or camcorder, press **INPUT 3** on the remote control or repeatedly press **INPUT** on the panel to select INPUT 3. For details on game console settings, refer to "2.5.2 Connect Your Other Pioneer Equipment" and to "4.1.4 Set the Panel to Recognize a Game Console."

Use the connection type specified by the equipment. Connect equipment only to terminals that are actually to be used.

5.6 Operate the Home Media Gallery

With Home Media Gallery, you can enjoy digital content such as movies, music, and photo files on your high-end flat panel TV. Play content from files stored on one or more media servers connected by a home or local area network (LAN) or those stored on a USB flash drive. After connecting via a broadband router or an Ethernet hub to a media server with network software, navigate through the digital content visible on the Home Media Gallery. The flat panel TV supports Mass Storage Class and PTP devices through USB interface and DLNA-compatible devices through a network.

DLNA CERTIFIED™ Audio/Video/Image Player

This unit complies with the DLNA Networked Device Interoperability Guidelines - expanded: October 2006 (v1.5). When a PC running DLNA server software or other DLNA-compatible device is connected to this player, some setting changes of software or other devices may be required. Please refer to the operating instructions for the software or device for more information.

Supported File Formats

The following sections show supported file formats that can be played back or displayed on the flat panel TV. These formats are applicable to network sources. Most are also applicable to USB sources. However, media server content protected by digital rights management such as WMDRM10 (Windows Media Digital Rights Management 10), may not play on the panel.

Supported Video Formats

- Windows Media Video 9 (WMV9): MP@ML
- Windows Media Video 9 (WMV9) Advanced Profile (VC-1): AP@L1, MP@ML
- MPEG-2 PS: MP@ML
- MPEG-2 TS: MP@ML
- MPEG-1
- MPEG-4 Part2 (SP/ASP): SP@L3, ASP@L5
- MPEG-4 Part10 (H.264/AVC): Main Profile 3.0

Supported Audio Formats

- Windows Media Audio 9 (WMA9): Sampling rates; 44.1 kHz or 48 kHz
- MPEG-1 Audio Layer 3 (MP3): Sampling rates; 32 kHz, 44.1 kHz or 48 kHz
- Linear PCM (WAV): Sampling rates; 44.1 kHz or 48 kHz
- MPEG-4 AAC: Sampling rates; 16 kHz, 32 kHz, 44.1 kHz or 48 kHz
- HE-AAC: Sampling rates; 16 kHz, 32 kHz, 44.1 kHz or 48 kHz

Supported Image Formats

- JPEG: Resolution; up to 3680 x 2760 pixels
- PNG: Resolution; up to 3680 x 2760 pixels
- GIF: Resolution; up to 3680 x 2760 pixels
- TIFF: Resolution; up to 1600 x 1200 pixels
- BMP: Resolution; up to 3072 x 2304 pixels

Supported File Extensions

This product supports the playback of files with the following extensions.

- Video: .wmv .asf .mpg .mpeg .mpe .m2p .m4v .mp4v, .mp4, .mov
- Audio: .wma .mp3 .wav .m4a .aac
- Image: .jpg .jpeg .png .gif .bmp .tif .tiff

Note: Even the supported format files that are listed above may or may not play properly or completely, depending on the media server, USB device, bit rate stream and other content characteristics, as well as other factors.

Even when files have a supported file extension, some files may not play or display properly, depending on the content or media server type.

Some formats may not be supported nor displayed on Home Media Gallery as formats that individual media servers support vary. Refer to the media server manufacturer's or other relevant websites for supported formats. Although a particular format is supported, not all content functions may operate properly. If the content fails to appear properly, contact the content producer for assistance. In addition, some supported file formats may fail to play properly when imported from an unknown USB device.

Note: You cannot use the Home Media Gallery until dimmed elements on the menu screen turn white.

Some Home Media Gallery functions, such as trick play during Fast Forward and Rewind, Time Search and Search, may not work depending on the media server's capability and functionality.

Home Media Gallery complies with the DLNA Networked Device Interoperability Guidelines - expanded: October 2006 (v1.5). If your media server supports different DLNA version(s), some Home Media Gallery function(s) and content format(s) may not be supported.

Pioneer is not responsible for any malfunction of the Home Media Gallery features due to communication error/malfunctions associated with your network connection and/or your PC, or other connected equipment. Contact your PC manufacturer or Internet service provider.

Content may not play or display properly, depending on the conditions of use or media server in use.

The Home Media Gallery functions as a WMDRM10-ND (Microsoft Windows Media DRM for networked devices). Content can only be navigated from the media servers that support WMDRM10-ND. Content may not play, depending on the DRM protection level.

This system may not display content from incompatible memory cards.

5.6.1 Network Connections

To connect to a network, set up the Home Media Gallery through the Home Media Gallery menu. Press the **HMG** button on the remote control to cause the menu to appear. To use the Home Media Gallery, connect to a home network (LAN) via an Ethernet hub or cable directly to a media server.

Usable Media Servers

A media server contains digital content such as movies, music, and photo files. PCs that have pre-installed media server software and recorders with a media server function are considered the media server. There are some media servers that you can choose from; for example, Windows Media Connect, Windows Media Player that has a media sharing function, and DLNA compliant servers.

- Windows Media Connect 2.0
Windows Media Connect runs on a 32-bit PC with Windows XP Service Pack 2 (SP2) installed. When it is already installed, you can enjoy Home Media Gallery using your PC.
- Windows Media Player 11 for Windows XP
Windows Media Player 11 features Media Sharing that runs on a 32-bit PC with Windows XP Service Pack 2 (SP2) installed.
If Windows Media Connect 2.0 is not installed in your PC, you can download Windows Media Player 11 from Microsoft's website.
- Windows Media Player 11 for Windows Vista
Windows Media Player 11 is featured in 32-bit Windows Vista PCs.

When selecting the most suitable media server, please visit Microsoft's website for system requirements, known issues, installation procedures, and other updated information.

- DLNA CERTIFIED™ digital media servers
The server is a DLNA-certified digital media server such as PC software, PCs and other devices installed with DLNA-certified software. When a PC running DLNA server software or other DLNA-compatible device is connected to this player, some setting changes of the software or device may be required. Refer to the device(s) operating instructions for more information.

Connect via an Ethernet Hub

If already operating one or more media servers on a home or local area network (LAN), connect the flat panel TV to the Ethernet (LAN) hub using a standard ("straight-through") Ethernet (LAN) cable. See the diagram below.

Note: Although the Home Media Gallery supports 10BASE-T, it is better to use 100BASE-TX for improved display quality and speed.

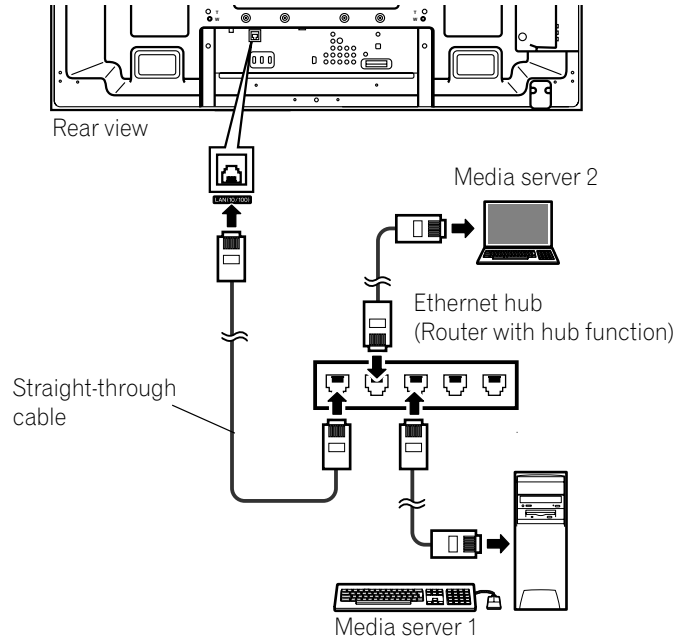

Connect directly to a Media Server

To run a PC as a media server, connect the flat panel TV directly to the PC using a twisted ("cross-over") Ethernet (LAN) cable. See the diagram below.

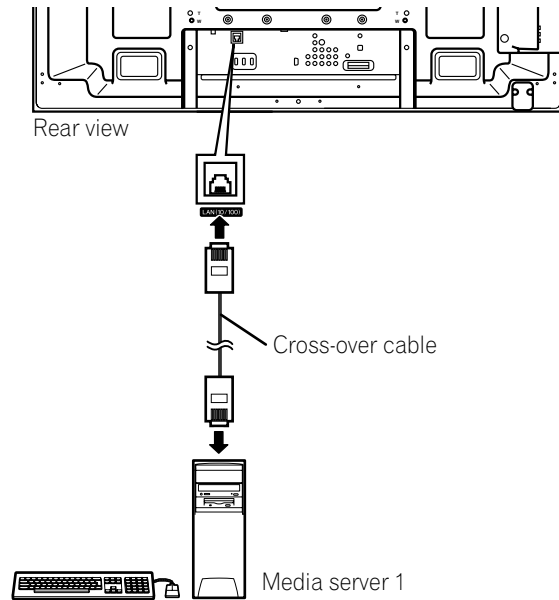

Confirm the IP Address

After making the network connection, follow the instructions below to confirm the IP Address before accessing the network. (The setup is effective for Auto only. To perform the procedure, DHCP on your server or router must be valid. See "5.9 HMG Setup")

- 1) Press **HMG** on the remote control.
The Home Media Gallery menu appears on screen.
- 2) Select *HMG Setup*.
Use the arrow buttons to highlight an option.
- 3) Press **ENTER**.
- 4) Select *Network Setup*.
- 5) Select *Auto DHCP*.
The screen turns from "Select" mode to "Input" mode.
- 6) Select *Yes*.
- 7) Press **RETURN**.
The HMG Setup screen returns.
The IP Address is assigned.

The Home Media Gallery supports Auto IP and DHCP (Dynamic Host Configuration Protocol). If the system failed to assign the IP Address or if you want to obtain different addresses, select No then enter IP Address and Subnet mask. See Network Setup or HMG Setup to enter an address manually.

For information on DHCP, refer to network device's operating instructions.

You may need to contact your service provider or network administrator when manually entering an IP Address. Some media servers block or are programmed to block access to client servers. When connecting the flat panel TV, check the media server for client server access rights.

5.6.2 Connect a USB Device

You can also enjoy content stored on memory cards by connecting a USB device to the flat panel TV. The root directory or Device List screen appears as soon as a USB flash drive or a multi-card reader is connected to the USB port. Another option is to connect your digital camera directly to the flat panel TV using a commercially available USB connector cable.

If for any reason, the Folder/Content List or Device List fails to appear, follow the steps below.

- 1) Press **HMG**.
The Home Media Gallery menu appears on screen.
- 2) Select *USB*.
Use the arrow buttons to highlight an option.
- 3) Press **ENTER** to confirm the selection.
- 4) Select the desired device.
The USB Device screen must be displayed.
- 5) Press **ENTER** to navigate to a folder or play a file/content.
To return to the previous screen, press RETURN.
- 6) Press **EXIT** or **HMG** to exit Home Media Gallery.

Notes: The flat panel TV displays the USB Device screen or root directory immediately after inserting a USB device. In this case, start from Step 5.

When a multi-card reader is inserted, the USB Device screen is displayed. In this case, start from Step 4.

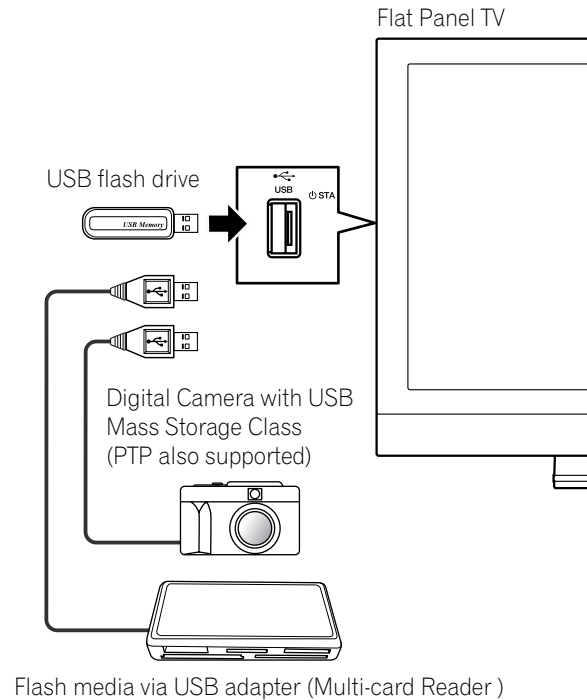

Note: Do not use any USB devices other than those specified. Using other devices can cause a malfunction.

Readable Data Format

This system reads FAT16, FAT32 or NTFS.

Readable Data Files

Movie, music, and photo files play with the exception of Digital Rights Management (WMDRM10) protected files.

Your flat panel TV supports a single USB device at a time. Also, the panel does not support USB hubs.

This system may not be able to display modified or edited content from a PC or other equipment.

Your flat panel TV supports the USB Mass Storage Class and PTP devices.

Some digital cameras may require a setup procedure for Mass Storage Class data transfer. The setup is done on the camera. See the operating instructions supplied with the digital camera. Depending on the type of your memory card or camera, some images may fail to display.

Remove a USB Device

To remove a USB device, exit the Home Media Gallery first then disconnect the device.

Be sure to exit the Home Media Gallery screen before removing the USB device. If you remove the USB device while the Home Media Gallery screen is displayed, data inside the memory may be damaged.

Do not insert or remove the USB device immediately after the system is switched On or Off. This action may cause data inside the memory to be damaged.

Pioneer is not liable for any loss or damage to the data inside the USB flash drive.

5.7 Run the Home Media Gallery

- 1) Press **HMG**.
The Home Media Gallery menu appears on screen.
- 2) Select *Media Navigator*, *USB*, *HMG Playlist* or *HMG Setup*.
*Use the arrow buttons to highlight an option then press **ENTER**.*
*To return to the previous screen, press **RETURN**.*
- 3) Press **EXIT** or **HMG** to exit Home Media Gallery.

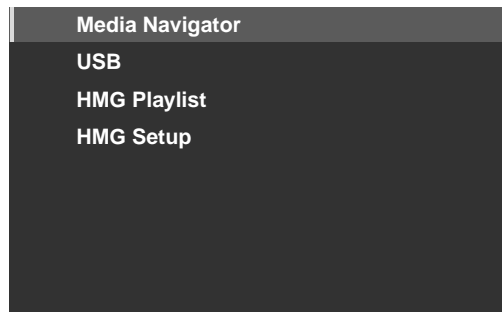

Use the Media Navigator

By selecting Media Navigator, the previously selected server menu automatically appears on the screen. When only one server is found, the system automatically connects the server. You can also use the TOOLS Menu to switch to another server or manually select a server from the Server List. The screen automatically changes to the Server List if there are no previous servers.

- 1) Press **HMG**.
The Home Media Gallery menu appears on screen.
- 2) Select *Media Navigator*.
*Use the arrow buttons to highlight an option then press **ENTER**.*
A server menu appears. The file/folder configuration may vary depending on the server selected.
- 3) Select a desired server from the Server List.
- 4) Select the desired folder to navigate or file/content to play.

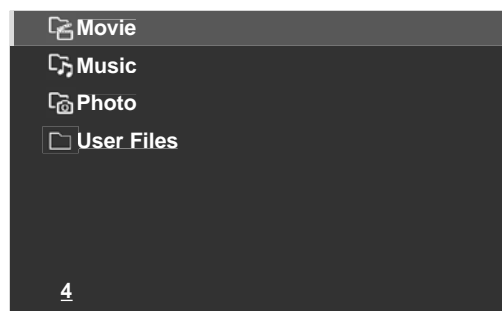

(Sample screen)

- 5) Press **ENTER**.
The appropriate Player launches and begins playing the selected file.
*To return to the previous screen, press **RETURN**.*
- 6) Press **EXIT** or **HMG** to exit Home Media Gallery.

*Note: The Media Navigator launch depends on the option selected in Auto Connection under "5.9 HMG Setup."
Select a server from the Server list to open Media Navigator.*

Navigate through a USB Device's Files and Folders

Like navigating through media servers, select the specific file from a device on the USB Device screen to start an appropriate player. For details, follow the steps below.

- 1) Press **HMG**.

The Home Media Gallery menu appears on screen.

- 2) Select **USB**.

*Use the arrow buttons to highlight an option then press **ENTER**.*

The USB Device screen appears. Select the device. When using a single directory device (USB flash drive), the USB Device screen does not appear.

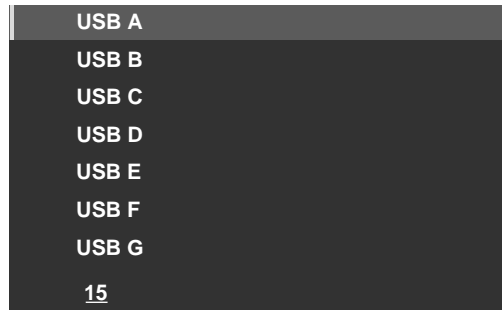

(Sample screen)

- 3) Select the desired folder to navigate or file/content to play.

- 4) Press **ENTER**.

The appropriate Player launches and begins playing the selected file.

*To return to the previous screen, press **RETURN**.*

- 5) Press **EXIT** or **HMG** to exit Home Media Gallery.

Note: The USB Device screen appears when using a multi-card reader or multiple flash drive devices. In this case, select the device containing the desired content.

Screen Components

Screen display options are:

- List
- Thumbnail
- Thumbnail List

Press **TOOLS** then select Change view from the TOOLS Menu to choose from the screen display options. The options are available for Movie, Music and Photo menus.

List screen

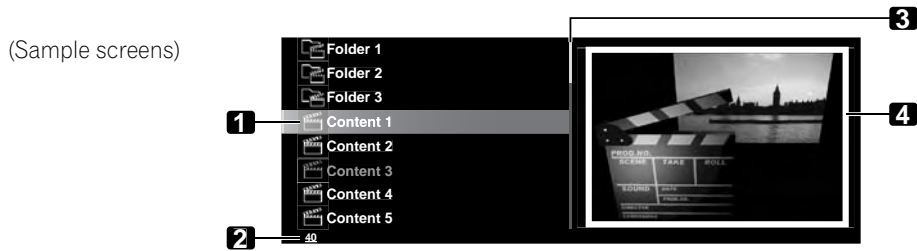

Thumbnail screen

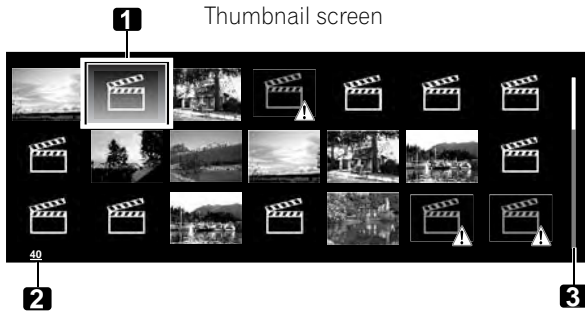

Thumbnail List screen

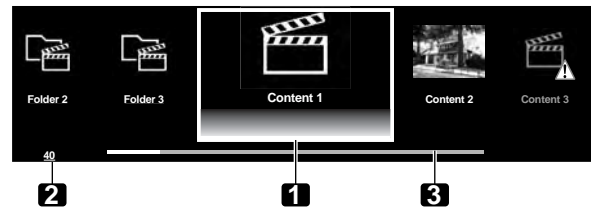

1. Item being selected
2. Number of total items
3. Scroll bar (displayed when one or more pages follow)
4. Icon or thumbnail of the selected item (if obtained)

HMG Playlist

Each category (Movie, Music, and Photo) has five different Playlists with up to 100 files each. The HMG Playlist can contain sound and image files selected in "Media Navigator". To edit a Playlist, use the TOOLS Menu.

- 1) Press **HMG**.
The Home Media Gallery menu appears on screen.
- 2) Select *HMG Playlist*.
*Use the arrow buttons to highlight an option then press **ENTER**.*
- 3) Select *Movie*, *Music* or *Photo* from the HMG Playlist screen.

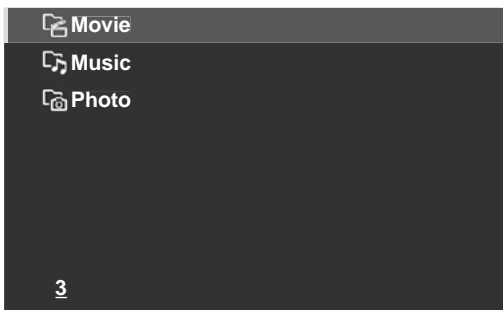

- 4) Select a desired list from Playlist 1 through Playlist 5.
- 5) Select the desired content.
*This menu can appear as a List, Thumbnail or Thumbnail List screen. Press **TOOLS** then select Change view from the TOOLS Menu to cycle through the views.*
- 6) Press **ENTER** to play the content.
*The appropriate Player launches and begins playing the selected file. To return to the previous screen, press **RETURN**.*
- 7) Press **EXIT** or **HMG** to exit Home Media Gallery.

5.7.1 Show Your Movie Files on the Flat Panel TV

When selecting movie content from the server menu on the Media Navigator screen or USB Device screen, the Movie Player automatically launches. Select a category, folder, or device to access the submenu containing the file or content.

Selecting a movie file from the HMG Playlist causes the Movie Player screen to appear, just like selecting a file from a server.

Screen Components

The following information automatically appears on screen for a few seconds when Movie Player launches or playback status changes (controlled by the remote, for example). Pressing **DISPLAY** or selecting Information on the TOOLS Menu also causes the information to appear.

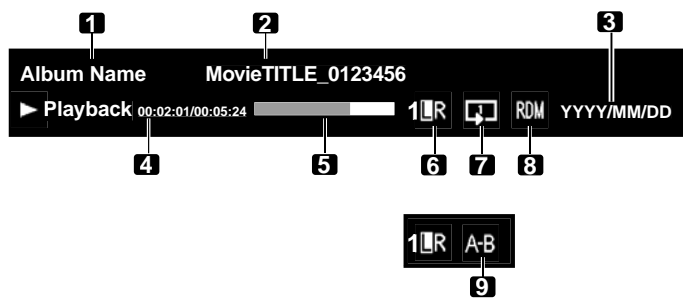

During A-B Repeat mode

(Content information)

1. Album name
2. Content title
3. Date

(Player status)

4. Playback status (status icon, status information, current time/total time)
5. Progress bar
6. Sound mode
7. Play mode
8. Random mode
9. A-B Repeat mode

Movie Player key guide

Mode	Key(s) used	Function
Playback	ENTER, ► (PLAY)	Plays back the content.
Stop	■ (STOP), RETURN	Stops the Movie Player and returns to the previous screen (List/Thumbnail/Thumbnail List)
PAUSE	ENTER, II (PAUSE)	Pauses the playback
Fast Forward	►► (FF), ➔	Fast forward while playback. Each press toggles the Fast Forward speed. To discontinue Fast Forward, press ENTER or PLAY . Normal playback mode returns.
Fast Reverse	◄◄ (RWD), ◄	Fast reverse while playback. Each press toggles the Fast Reverse speed. To discontinue Fast Reverse, press ENTER or PLAY . Normal playback mode returns.
Slow Forward	II + ➔, II + ►►	Slow forward when in PAUSE. Each press toggles the Slow Forward speed. To discontinue Slow Forward, press ENTER or PLAY . Normal playback mode returns. <i>Note: This function may not be supported, depending on the content.</i>
Forward (15 sec.)	↑	Skips 15 seconds forward then plays back the video or pauses while in PAUSE
Reverse (15 sec.)	↓	Skips 15 seconds backward then plays back the video or pauses while in PAUSE
Time Search	TOOLS	See <i>Use the TOOLS Menu</i>
Add to HMG Playlist	TOOLS	See <i>Use the TOOLS Menu</i>
A-B Repeat Mode	TOOLS	See <i>Use the TOOLS Menu</i>
Random	TOOLS	See <i>Use the TOOLS Menu</i>
Play Mode	TOOLS	See <i>Use the TOOLS Menu</i>
Audio	TOOLS	See <i>Use the TOOLS Menu</i>
Picture	TOOLS	See <i>Use the TOOLS Menu</i>
Sound	TOOLS	See <i>Use the TOOLS Menu</i>
Information	TOOLS	See <i>Use the TOOLS Menu</i>

*Note: Some functions may not be supported depending on the server type or software version.
During playback, an error may arise in time-related information, depending on the content or server software.
Also, some functions may not be supported, depending on the content.*

Content obtained from a digital video camera that supports H.264/AVC format can be played through the USB port.

To play content from this type of camera, follow the steps below.

- 1) Insert the USB flash drive containing the content into a card reader connected to the flat panel TV.
*The USB device's Folder/Contents List appears on screen.
Refer to the operation manual that came with the individual device for connection and setting help.*
- 2) Select a Folder/Contents List.
*Use the arrow buttons to highlight an option then press **ENTER**.*
- 3) Select the desired content.

Note: Some content may not be played back or may be a short delay between audio and video, depending on the file.

Not all files (including edited files) may be supported with the Movie Player. Stored content may not appear in the "Shortcut" folder, depending on the saved position in the memory device.

Also, content may not play properly, depending on the USB card reader used.

5.7.2 Play Your Music Files on the Flat Panel TV

When selecting music content from the server menu (on the Media Navigator screen or from the USB Device screen), the Music Player automatically launches. Select a category, folder, or device to access the submenu containing your file or content. Selecting a music file from HMG Playlist causes the Music Player screen to appear, just like selecting a file from a server.

After playing music content through once, the music content loops as background music (BGM). To stop looping, stop the playback, exit the Home Media Gallery or start playing content other than photo content.

Screen Components

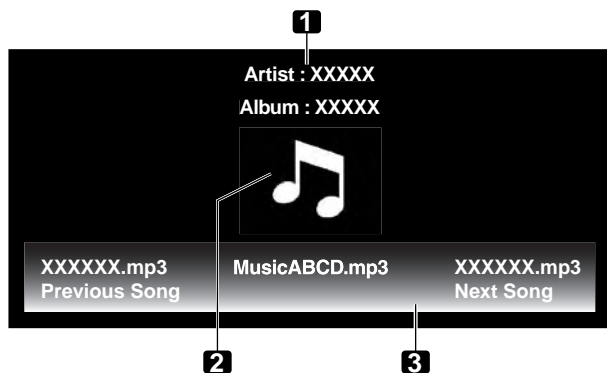

1. Artist/album information
2. Music Player thumbnail icon/jacket image
3. Player list

The following information and playback status appear on the Music Player screen.

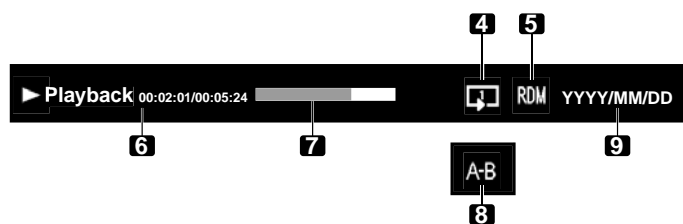

4. Play mode
5. Random mode
6. Playback status (status icon, status information, current time/total time)
7. Progress bar
8. A-B Repeat mode
9. Date

During A-B Repeat mode

Music Player key guide

Mode	Key(s) used	Function
Playback	ENTER, ► (PLAY)	Plays back the selected content.
Stop	■ (STOP), ↓	Stops the playback
PAUSE	ENTER, II (PAUSE)	Pauses the playback
Fast Forward	►► (FF)	See the Movie Player key guide.
	→	Press and hold → to start Fast Forward. When in Fast Forward, press → to change the playback speed. To discontinue Fast Forward, press ENTER or PLAY . Normal playback mode returns.
Fast Reverse	◄◄ (RWD)	See the Movie Player key guide.
	←	Press and hold ← to start Fast Reverse. When in Fast Reverse, press ← to change the playback speed. To discontinue Fast Reverse, press ENTER or PLAY . Normal playback mode returns.
Next	→	Selects the next content
Previous	←	Selects the previous content
Time Search	TOOLS	See <i>Use the TOOLS Menu</i>
Add to HMG Playlist	TOOLS	See <i>Use the TOOLS Menu</i>
Random	TOOLS	See <i>Use the TOOLS Menu</i>
A-B Repeat	TOOLS	See <i>Use the TOOLS Menu</i>
Play Mode	TOOLS	See <i>Use the TOOLS Menu</i>
Sound	TOOLS	See <i>Use the TOOLS Menu</i>

*Note: Files may not play properly, depending on the content.
Some functions may not be supported, depending on the server type or software version.
Playback continues. Pressing **RETURN** to move from the Player screen to the previously selected screen has no effect.*

5.7.3 Show Your Photo File on the Flat Panel TV

When selecting photo content from the Media Navigator’s server menu or from the USB Device screen, the Photo Player automatically launches. Press **ENTER** to show content in full screen. Select a category, folder or device to access the submenu containing your file or content.

Selecting a photo file from the HMG Playlist causes the Photo Player screen to appear, just like selecting a file from the server.

Screen Components

The following information automatically appears on screen for a few seconds when Photo Player launches or playback status changes (controlled by the remote, for example). Pressing **DISPLAY** or selecting Information on the **TOOLS** Menu also causes the information to appear.

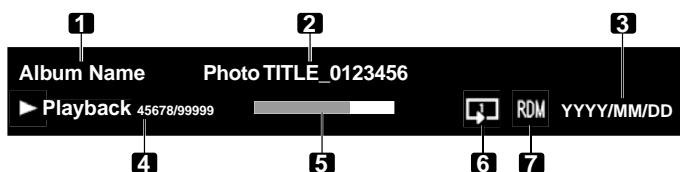

- (Content information)
1. Album name
 2. Content title
 3. Date
- (Player status)
4. Playback status (status icon, status information, current number/total number)
 5. Progress bar
 6. Play mode
 7. Random mode

Photo Player key guide

Mode	Key(s) used	Function
Playback	ENTER, ► (PLAY)	Starts displaying a photo or playing a slideshow when in playback
Stop	■ (STOP), RETURN	Stops the Player and returns to the previous screen (List/Thumbnail/Thumbnail List)
PAUSE	ENTER while playback, ⏸ (PAUSE)	Pauses the slideshow
Move File Forward	➡	Displays the next image content
Move File Backward	⬅	Displays the previous image content
Rotate (clockwise)	▶▶ (FF), TOOLS	Rotates the image 90° clockwise. Each press toggles the rotation angle by 90° between 90°, 180°, 270° and 0°. (See <i>Use the TOOLS Menu</i>)
Rotate (counter-clockwise)	◀◀ (RWD)	Rotates the image 90° counter-clockwise. Each press toggles the rotation angle by 90° between 270°, 180°, 90° and 0°.
Change BGM	↑, ↓	Switches BGM content while playing BGM
Zoom	TOOLS	See <i>Use the TOOLS Menu</i>
Add to HMG Playlist	TOOLS	See <i>Use the TOOLS Menu</i>
Random	TOOLS	See <i>Use the TOOLS Menu</i>
Play Mode	TOOLS	See <i>Use the TOOLS Menu</i>
Slide Show	TOOLS	See <i>Use the TOOLS Menu</i>
Music Player	TOOLS	See <i>Use the TOOLS Menu</i>
Picture	TOOLS	See <i>Use the TOOLS Menu</i>
Sound	TOOLS	See <i>Use the TOOLS Menu</i>
Information	TOOLS	See <i>Use the TOOLS Menu</i>

Note: Some functions may not be supported, depending on the server type or software version. Even files in the supported format may fail to play properly, depending on the content.

5.8 Use the TOOLS Menu

Pressing **TOOLS** on the remote control causes the TOOLS Menu to appear. Select various play and display modes from this menu. The selectable menu items differ, depending on the current menu (refer to "3.6.1 Use the TOOLS Menu").

Update Server List

Use this function to update the currently selected Server List. This option is available on the Server List screen regardless if the server is connected to your flat panel TV.

- 1) Press **TOOLS** while showing the Server List.

The TOOLS Menu appears on screen.

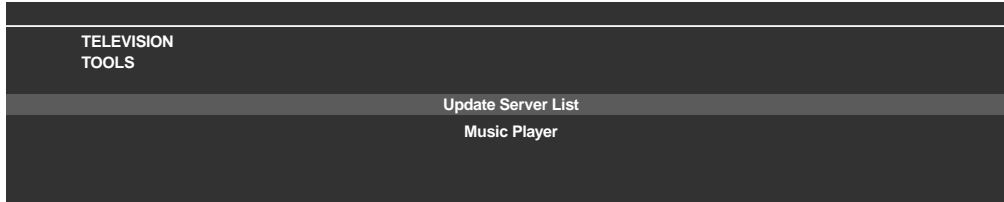

- 2) Select *Update Server List* from the TOOLS Menu.
Use the arrow buttons to highlight an option then press **ENTER**.
Information on the connected server is updated.

Delete Server

Your flat panel TV allows disconnected servers to be removed from the Server List.

To delete a server, follow the steps below. This option is available on the Server List screen (server not connected).

- 1) Press **TOOLS** while the cursor is on the unconnected server on the Server List screen.

The TOOLS Menu appears on screen.

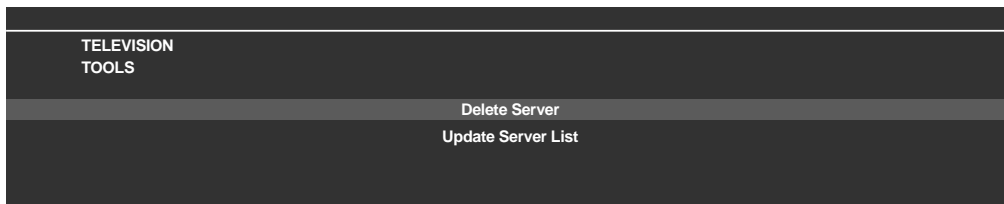

- 2) Select *Delete Server* from the TOOLS Menu.
A Delete Server screen appears.
- 3) Select *Yes* then press **ENTER**.
The server disappears from the list.
To cancel the server deletion, select No.

USB Device

The TOOLS menu provides a screen to see what USB device(s) are connected or supported. Follow the directions below to open the USB Device screen. This option is available on the Folder/Contents List (USB) screen.

- 1) Press **TOOLS**.

The TOOLS Menu appears on screen.

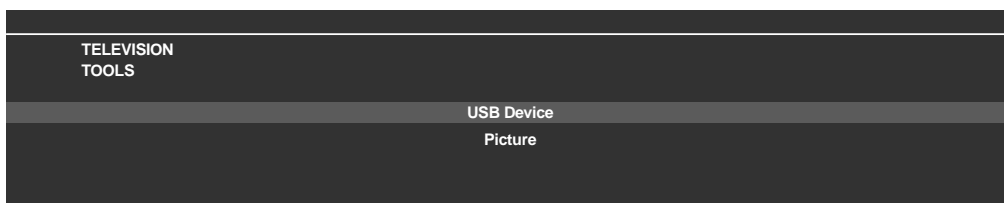

- 2) Select *USB Device* from the TOOLS Menu.
A USB Device screen appears, showing currently connected USB devices.

Favorites Entry

Registering the Home Media Gallery in Favorites (TOOLS Menu) provides quick access to the Home Media Gallery top screen while watching TV or other programs. This option is available on the Home Media Gallery screen.

- 1) Press **TOOLS**.

The TOOLS Menu appears on screen.

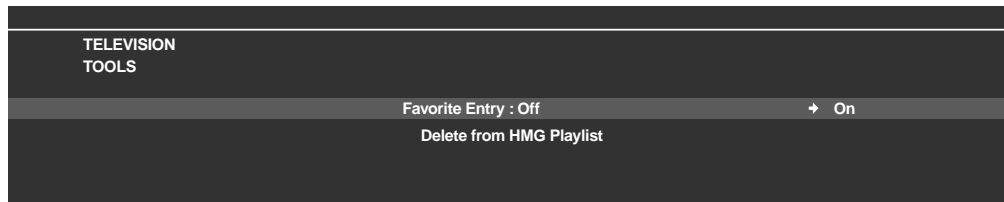

- 2) Select *Favorites Entry*.

- 3) Set the option to *On* then press **ENTER**.

Registration completes.

To remove the Home Media Gallery from Favorites, select Off.

Detailed Display

Select this option to display the detailed information on the current content. This option is available on the Media Navigator, Playlist List (Movie/Music/Photo), and Folder/Contents List screens.

- 1) Press **TOOLS**.

The TOOLS Menu appears on screen.

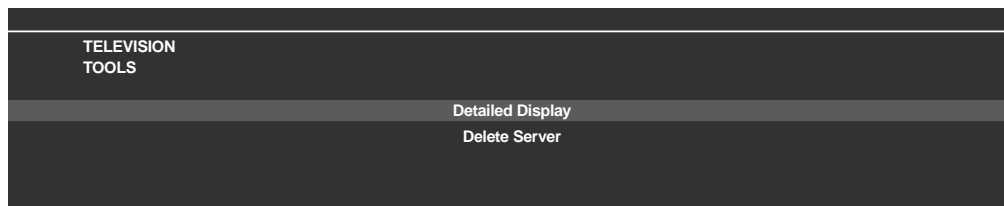

- 2) Select *Detailed Display* from the TOOLS Menu.

Detailed information appears.

Pressing RETURN causes the information to disappear and the previous screen to return.

Sort

A sort option is available under Media Navigator and Folder/Contents List screens. This function is unavailable for folders or content on a USB device. To sort the items contained in the Folder/Contents List, follow the steps below.

- 1) Press **HMG**.

The Home Media Gallery menu appears on screen.

- 2) Select the desired folder and/or content in the Media Navigator.

Use the arrow buttons to highlight an option then press ENTER.

- 3) Press **TOOLS** then select *Sort* from the TOOLS Menu.

A Sort dialog screen appears.

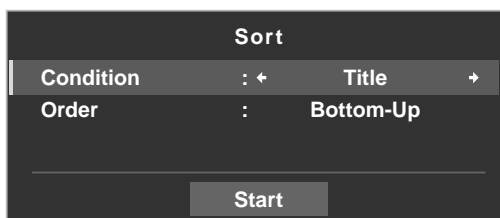

- 4) Select the appropriate option on the Sort dialog screen.

- *Condition: Title, Track Number, Genre, Artist or Date.*

- Order: Bottom-Up or Top-Down

5) Select *Start* on the Sort dialog screen.

The sorting starts based on your selection and sort results are displayed.

*While sorting continues, content playback is available. To return to the sort screen, press **RETURN** any time during playback.*

*To cancel the sort mode, press **RETURN**.*

Notes: The "Select a sorting order." screen is available and may be left on the screen while navigating through the music categories.

Sort may not be available, depending on the server used.

Available submenus for Condition vary, depending on the server used.

Search

The flat panel TV's built-in Search function provides a convenient way to find items held in a Folder/Contents List. However, the searching function is unavailable for folders or content on a USB device.

Simply enter a word and the results appear on screen. To begin a Search, follow the directions below. This option is available on the Media Navigator and Folder/Contents List screens.

1) Press **HMG**.

The Home Media Gallery menu appears on screen.

2) Select the desired folder and/or content in the Media Navigator.

*Use the arrow buttons to highlight an option then press **ENTER**.*

3) Press **TOOLS**.

The TOOLS Menu appears on screen.

4) Select *Search* from the TOOLS Menu.

A Search dialog screen appears.

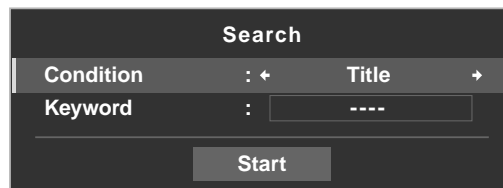

5) Select *Title*, *Genre* or *Artist* for *Condition*, or enter a *Keyword*.

*Pressing **ENTER** on the Keyword menu causes the software keyboard to appear on the screen.*

6) Enter the word on the software keyboard.

Refer to "Software Keyboard" under "3.2.5 Create the List of Channels" for operation details.

7) Select *OK* on the software keyboard to bring up the Search dialog screen and hide the keyboard.

*To cancel the key word entry, select *Cancel*.*

8) Select *Start* on the Search dialog screen.

The searching starts based on the word entered with results are appearing on screen.

*While searching continues, content is playable. To return to the search screen, press **RETURN** any time during playback.*

*To cancel the search mode, press **RETURN**.*

Notes: The Search function may not be available, depending on the server.

Available submenus for Condition vary, depending on the server used.

Slide Show

A slideshow is simply a series of still pictures, appearing one after the other, usually in a timed procession. Select the desired photo file to display a still picture then press **ENTER** to start a slideshow. After a slideshow launches, pressing **ENTER** toggles between PLAY and PAUSE. Or press **PLAY** to start the slideshow immediately. This option is available on the Media Navigator, Folder/Contents List, and Photo Player. You can set the Photo Player to play a slideshow with background music (BGM) and various visual effects. To begin a slideshow, follow the directions below.

- 1) Press **HMG**.
The Home Media Gallery menu appears on screen.
- 2) Select *Media Navigator* or *USB* from the menu.
*Use the arrow buttons to highlight an option then press **ENTER**.*
- 3) Select a folder containing photo content.
*Use the arrow buttons to highlight a folder then press **ENTER**.*
The Thumbnail screen appears (Thumbnail List or List screen appears, depending on the setting).
- 4) Select the desired photo file.
The selected photo content appears in full screen.
- 5) Press **TOOLS**.
The TOOLS Menu appears on screen.
- 6) Select a slideshow option.
- 7) Select an Effect: *Off, Black Out* or *Panoramic*.
- 8) Select a time interval: *3Seconds, 5Seconds, 10Seconds, 15Seconds, 30Seconds* or *60Seconds*.



- 9) Turn the Random option *Off* or *On*.
For details, refer to Random.
- 10) Select the desired option for *Play Mode*.
Select Single, Repeat, Repeat All or All. For details, refer to "Play Mode" (page 101).
- 11) Select any desired *BGM*.
Select music content from Playlist 1 through 5 or the USB device.
- 12) Select *Start*.
The slideshow starts and photo images in the folder automatically appear one by one.
*To force the next image to appear, press **→**.*
*To force the previous image to return, press **←**.*
- 13) Press **ENTER** or **II** (Pause) to stop the slideshow.
The Photo Player pauses.
- 14) Press **ENTER** again to resume the slideshow.
*To cancel the slideshow and stop the Photo Player, press **RETURN** or **■** (Stop) during playback. The previous screen returns.*

Note: After setting the Interval time, it may take longer than the preset time. As the Interval time refers to the time length up until the Home Media Gallery starts to obtain the next image. Key operations may not work while obtaining the next image.

Add to HMG Playlist

The Home Media Gallery function provides "HMG Playlist" - a self-contained play list that allows bookmarking favorite movie, music, and photo files from the network. You can store, edit, and sort up to 100 files in each Playlist List. This option is available on the Media Navigator, Folder/Contents List, Movie Player, Music Player, and Photo Player screens.

- 1) While navigating or playing, select the file to be added to a HMG Playlist.
- 2) Press **TOOLS**.
The TOOLS Menu appears on screen.
- 3) Select *Add to HMG Playlist* from the TOOLS Menu.
An Add to HMG Playlist dialog screen appears.
- 4) Select a Playlist.
Press ←/→ to select from Playlist 1 to Playlist 5.

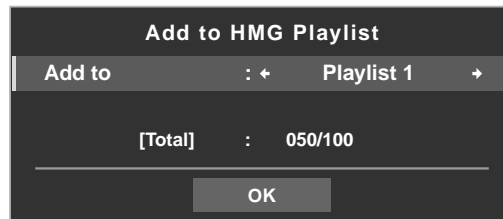

- 5) Select *OK*.
To select other Playlist(s), repeat Steps 2 to 5.
The file is added to the selected Playlist. The Total field changes as content is added to the playlist.
To cancel the operation, press RETURN.

Select Server

When one or more servers are connected within the network, you can switch between servers. This option is available on the Media Navigator and Folder/Contents List screens.

- 1) Press **TOOLS**.
The TOOLS Menu appears on screen.
- 2) Select *Select Server* from the TOOLS Menu.
The Server List appears.



(Sample screen)

- 3) Select the desired server.
The screen changes to Media Navigator on the selected server.

Notes: The Home Media Gallery can memorize previously connected servers. When the Media Navigator is launched, available servers are automatically located and connected.

If a previously connected server cannot be found or if the server is in sleep mode, the server name is dimmed.

*In some cases, media servers that support "Wake On LAN" can be booted up. Select the server then press **ENTER** to transmit a "Wake On LAN" command to the highlighted server.*

When having "Wake On LAN" turns the server's power on, the server must be ready with the necessary settings already completed.

Play Mode

Your flat panel TV provides four repeat modes when using the Movie Player, Music Player, or Photo Player. Choose a playback mode (Repeat, Single, etc.) when playing multiple content files. To activate Play Mode, follow the steps below.

- 1) While playing content, press **TOOLS**.
The TOOLS Menu appears on screen.
- 2) Select *Play Mode* from TOOLS Menu.
Select Single, Repeat, Repeat All or All.
Single: Plays the selected content only once
Repeat: Plays the selected content in a loop
Repeat All: Loop-plays all contents in a folder in order (when the last content file ends, the first file begins to play with all subsequent files playing in order continually).
All: Plays all selected folder content in order only once

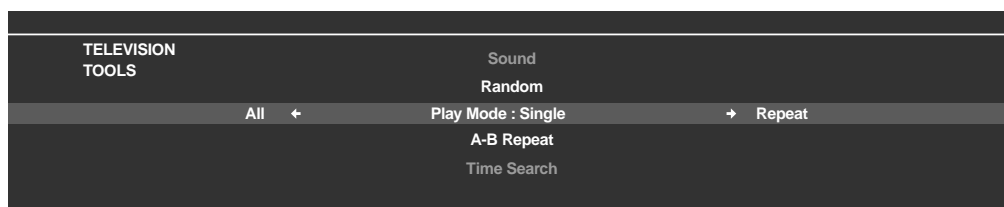

Change Name

Playlist (1 through 5) can be renamed in HMG Playlist. To name a Playlist, follow the directions below. This option is available on the Playlist List (Movie/Music/Photo) screen.

- 1) Press **TOOLS** while five Playlists in the HMG Playlist are on screen.
The TOOLS Menu appears on screen.
- 2) Select *Change Name* from the TOOLS Menu.
The software keyboard appears.

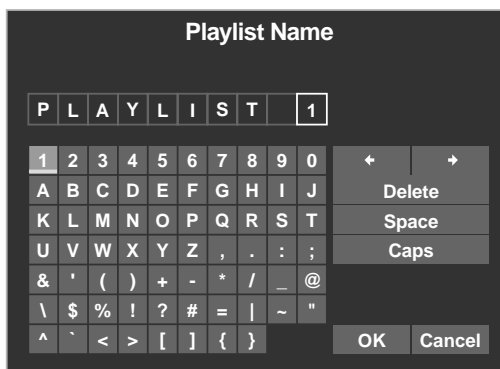

- 3) Enter the new name.
Refer to "Software Keyboard" under "3.2.5 Create the List of Channels" for operation details.
- 4) Select *OK* after the new name is entered on the software keyboard.
The software keyboard disappears and the newly named Playlist appears.
Selecting Cancel causes the entry to stop and cancels the name entry process.

Change View

Select this option to cycle between the different views: List, Thumbnail, and Thumbnail List. This option is available on the Playlist List (Movie/Music/Photo), and Folder/Contents List screens.

- 1) Press **TOOLS**.
The TOOLS Menu appears on screen.
- 2) Select *Change View* from the TOOLS Menu.
Select the screen option from List, Thumbnail or Thumbnail List.

TOOLS Menu

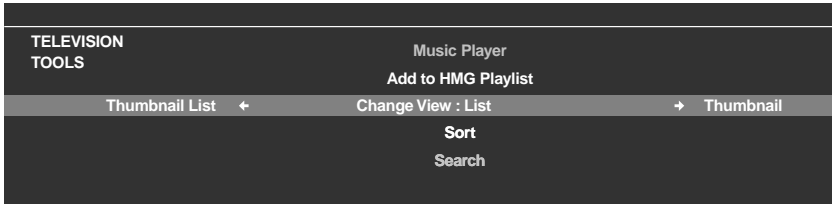

List screen



Thumbnail screen

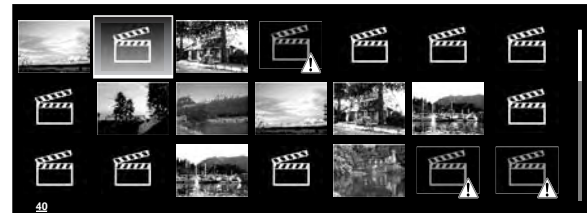

Thumbnail List screen



(Sample screens)

Time Search

The Time Search function allows the content to start playing at the preset time. This option is available on the Movie Player and Music Player screens.

To allow Time Search, follow the steps below.

- 1) While playing content, press **TOOLS**.
The TOOLS Menu appears on screen.
- 2) Select *Time Search* from the TOOLS Menu.
A Time Search dialog screen appears.

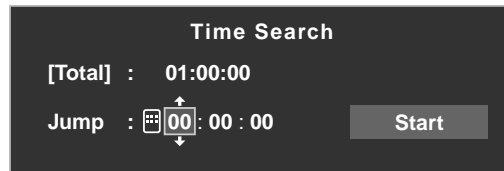

- 3) Enter the time (Hour, Minute and/or Second) to jump to.
Enter Hour and Minute for movie content or Minute and Second for music content.
Use ↑/↓ or buttons 0 to 9 (if a numeric key icon appears).
Press ←/→ to select Hour and Minute (movie content) or Minute and Second (music content).
- 4) Select *Start* then press **ENTER** to begin the time search.
The movie (music) begins playing from the set time. To cancel the Time Search, press RETURN.

Note: The Time Search function may not be supported, depending on the content, server software or software version.

An error may arise in time-related information, depending on the content or server software.

Picture

The Picture option is another way to adjust the image quality. This option is available on the Movie Player and Photo Player screens. To adjust the picture, follow the steps below.

- 1) Press **TOOLS**.
The TOOLS Menu appears on screen.

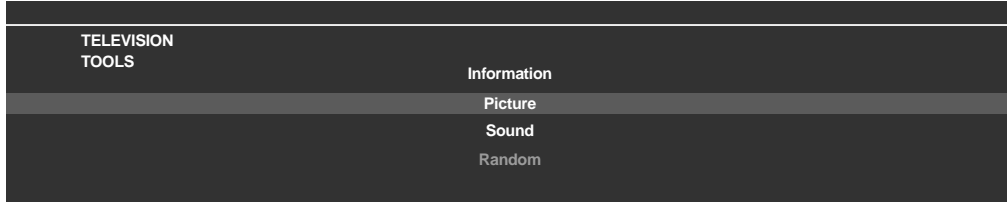

- 2) Select *Picture* from the TOOLS Menu.
A picture adjustment screen appears. For adjustment items, see "3.4 Adjust the Picture and Sound Quality."
- 3) Press **RETURN** to close the adjustment screen.
Normal playback screen returns.

Sound

This Sound option is another way to adjust audio quality. This option is available on the Movie Player, Music Player and Photo Player screens. To adjust the sound, follow the steps below.

- 1) Press **TOOLS**.
The TOOLS Menu appears on screen.

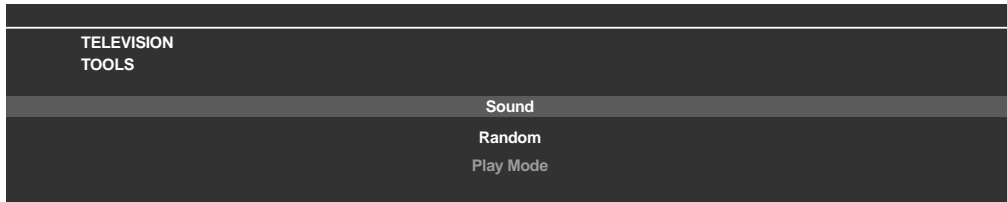

- 2) Select *Sound* from the TOOLS Menu.
A sound adjustment screen appears. For adjustment items, see "3.4 Adjust the Picture and Sound Quality."
- 3) Press **RETURN** to close the adjustment screen.
Normal playback screen returns.

Information

The Information option displays the status information on the playing content. This option is available on the Movie Player and Photo Player screens. To show information during playback, follow the steps below.

- 1) Press **TOOLS**.
The TOOLS Menu appears on screen.

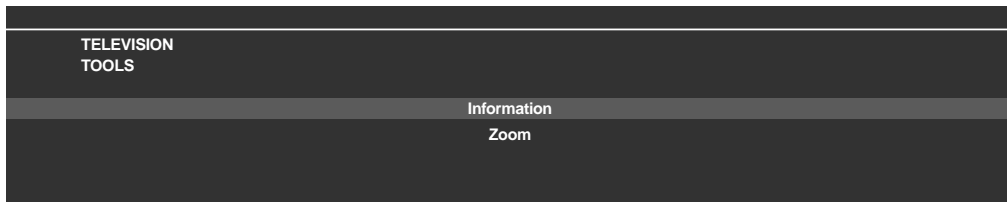

- 2) Select *Information* from the TOOLS Menu.
*An information (such as playback status) screen appears. Pressing **DISPLAY** also causes the information screen to appear.
The screen automatically disappears after a short period of time.*

Audio

Use this option to switch to another audio source if the currently played content has multiple audio sources (multi-language content, for example). This option is available on the Movie Player screen. To reveal multiple audio tracks, follow the steps below.

- 1) Press **TOOLS**.

The TOOLS Menu appears on screen.

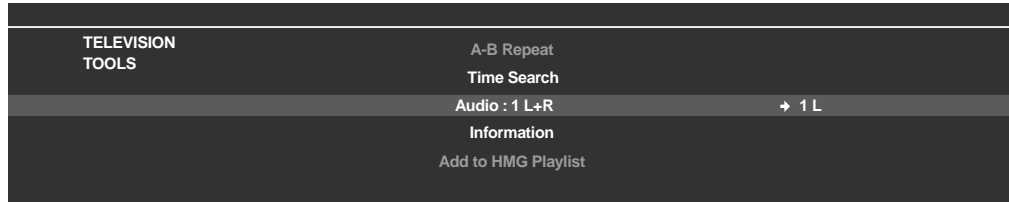

- 2) Select *Audio* from the TOOLS Menu.

Pressing ←/→ causes L, R or L+R to be selected. If the content has multiple audio sources, select L, R or L+R for each source.

- 3) After entering the setting, press **RETURN**.

Music Player

The Music Player option allows changing BGM on any screen rather than using the music from the content. This option is only available when music is played on any screen other than Movie Player and Music Player. Music Player is available on the Media Navigator, Folder/Contents List, USB, HMG Playlist, Playlist List, and Photo Player screens. To activate Music Player, follow the steps below.

- 1) Press **TOOLS**.

The TOOLS Menu appears on screen.



- 2) Select *Music Player* from the TOOLS Menu.

The Music Player screen appears.

*After entering the setting, press **RETURN**. The previous screen returns.*

Move

To show files in your preferred order, use the Move option to change the listing order in the HMG Playlist. This option is available on the Contents List (Playlist) screen.

- 1) Move the cursor to the content to be moved within the HMG Playlist.

- 2) Press **TOOLS**.

The TOOLS Menu appears on screen.

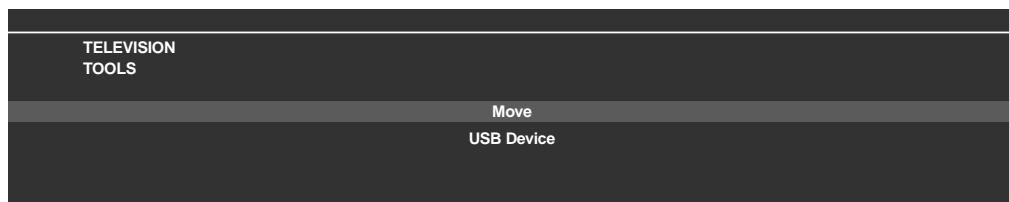

- 3) Select *Move* from the TOOLS Menu.

- 4) Press **↑/↓** to move the content up or down.

- 5) Press **ENTER**.
Editing completes and Move finishes.

Delete from HMG Playlist

Sometimes a file is no longer wanted. Your flat panel TV provides a method to delete content from a HMG Playlist. This option is available on the Contents List (Playlist) screen. To delete content from a Playlist, follow the steps below.

- 1) Move the cursor to the content to be deleted from the HMG Playlist.
- 2) Press **TOOLS**.
The TOOLS Menu appears on screen.

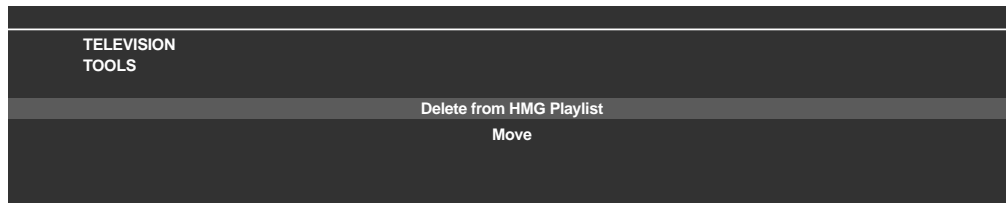

- 3) Select *Delete from HMG Playlist* on the TOOLS Menu.
A Delete from HMG Playlist dialog screen appears.
- 4) Select *Yes* to remove the content item.
The dialog screen disappears and the selected content is deleted from the HMG Playlist. To cancel, select No.

A-B Repeat Mode

Use this option to play the selected movie scenes or music programs repeatedly. This option is available only during normal playback on the Movie Player or Music Player.

To set Repeat, follow the steps below.

- 1) While playing content, press **TOOLS**.
The TOOLS Menu appears on screen.

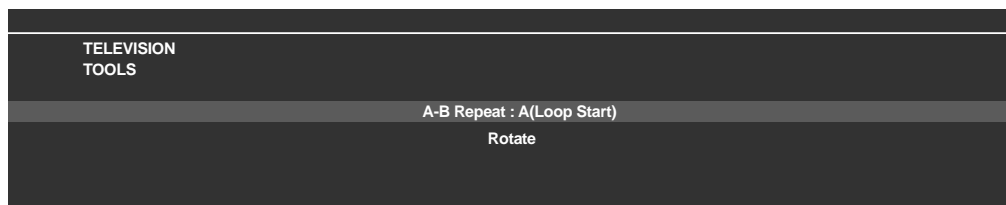

- 2) Select *A-B Repeat* from the TOOLS Menu.
- 3) Press **ENTER** to mark a starting point.
- 4) Press **ENTER** again where the playback needs to stop.
The Player status appears on the screen and the A-B Repeat mode icon changes.

The selected part of the content begins looping.

To end the looping and return to normal playback, press **TOOLS** then select Off while in the *A-B Repeat* mode.

Note: If the screen display fails to match the player status, a malfunction may have occurred. Stop playback then try the operation again.

Random

Use this option to shuffle the order in the content list, playing the content at random. This option is available on the Movie Player, Music Player and Photo Player screens. To shuffle the playlist, follow the steps below.

- 1) While playing content, press **TOOLS**.
The TOOLS Menu appears on screen.

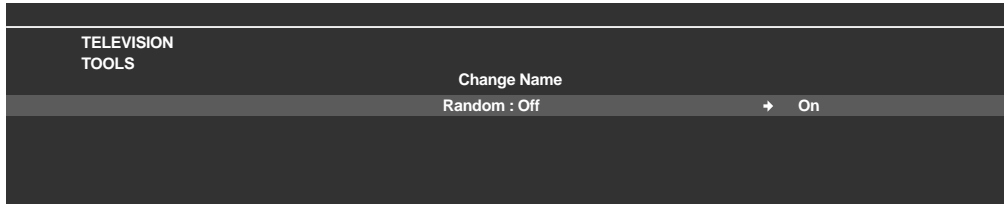

- 2) Select *Random* from the TOOLS Menu.
- 3) Select *On*.
Random Repeat playback starts.
*To cancel the random mode, press **TOOLS** and select *Off*.*

Note: Random Repeat is only available for content playing in Repeat Mode (except when Single is selected).

Rotate

Use the Rotate option to turn an image 90° clockwise. This option is available on the Photo Player screen. To rotate an image, follow the steps below.

- 1) While photo content appears, press **TOOLS**.
The TOOLS Menu appears on screen.

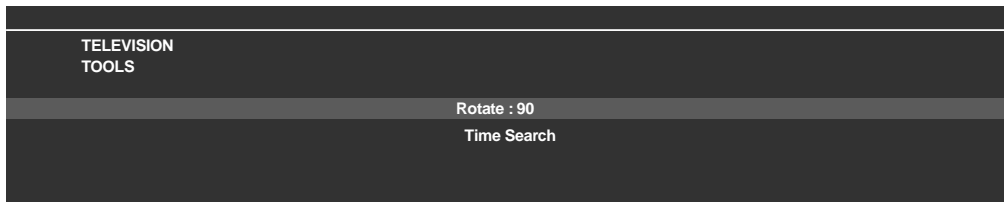

- 2) Select *Rotate* from the TOOLS Menu.
*Each press of the **ENTER** button causes the displayed image to rotate by one quarter clockwise. It toggles between 90°, 180°, 270° and 0°.*

Note: The selected rotation angle is only effective for the visible image.
Moving or changing the content causes the image to reset to the default view.

Zoom

Use the Zoom option to enlarge the photo content displayed. This option is available on the Photo Player screen. To enlarge content, follow the steps below.

- 1) While photo content appears, press **TOOLS**.

The TOOLS Menu appears on screen.

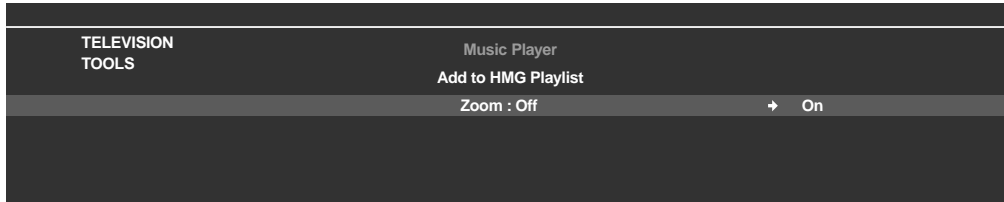

- 2) Select *Zoom* from the TOOLS Menu.

- 3) Press **←/→** to select *On* or *Off*.

- 4) Press **ENTER** to confirm the selection.

Selecting On causes the enlarged photo content to always appear.

Displayed image differs depending on the content. If the content's aspect ratio is longer than 16:9, it appears fully stretched horizontally to both sides with images cropped at the top and bottom. If the content's aspect ratio is wider than 16:9, it appears fully stretched vertically to top and bottom with images cropped on the right and left sides.

A "zoom" icon appears on screen.

- 5) While in Zoom mode, use the arrow buttons to scroll the content.

*Press **↑** or **↓** if the content's aspect ratio is longer than 16:9, **←** or **→** if the content's aspect ratio is wider than 16:9.*

- 6) Press **RETURN** or **ENTER** to cancel the Zoom and return to the normal screen.

Note: The Zoom function is disabled when the content is a 16:9 picture.

5.9 HMG Setup

Use the HMG Setup option for Network Setup, Auto Connection Setup and Default Settings. For more information about each option, refer to the following sections.

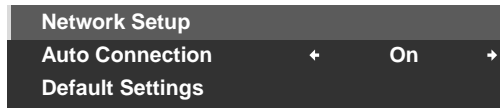

Network Setup

Select whether to acquire the IP Address automatically or manually or, when acquiring manually, set the IP Address and Subnet mask. To access the Network Setup menu, follow the steps below.

Automatic:

To perform the procedure, DHCP on your server or router must be valid.

- 1) Press **HMG**.
The Home Media Gallery menu appears on screen.
- 2) Select *HMG Setup* from the menu.
*Use the arrow buttons to highlight an option then press **ENTER**.*
- 3) Select *Network Setup*.
- 4) Select *Auto DHCP*.
- 5) Select *Yes*.
The flat panel TV seeks and acquires an IP Address if available.
- 6) Press **EXIT** or **HMG** to exit Home Media Gallery.

Manual:

Before activating, check your media server for IP Address and Subnet mask information.

- 1) Access the *Network Setup* through the *HMG Setup*.
- 2) Select *Auto DHCP*.
- 3) Select *No*.
- 4) Select the appropriate box.
*Use **↑** or **↓** to highlight an entry item (IP Address or Subnet mask) then press **ENTER**.
No need to enter Default Gateway and DNS Server data.*
- 5) Enter the figures using buttons **0** to **9**.
*Subnet mask (such as 255.255.255.0): Enter the same figures.
IP Address (such as 192.168.201.***): Enter the same figures as used in the media server (PC, etc.). For ***, enter 3-digit figures (0 – 254) that have not been used for other network connections.
Use **←** or **→** to highlight other entry areas.*
- 6) Press **ENTER** on the appropriate box after the entry is complete.
Repeat Steps 4 to 5 to complete Network setup.
- 7) Press **EXIT** or **HMG** to exit Home Media Gallery.

Auto Connection

Set Auto Connection to automatically connect to the last accessed server.
For selection, follow the steps below.

- 1) Access the *Auto Connection* through the *HMG Setup*.
- 2) Use **←** or **→** to change the setting.
Selecting ON causes the display to access the last server. If the server is in Standby, a WOL ("Wake On LAN") is sent to turn the last accessed server On.
Selecting OFF causes a server list to appear on screen.
"Wake on LAN (WOL)" turns the last accessed server's power on if the server is WOL-compliant and is in Standby or sleep mode, once the server is awake, the Media Navigator screen appears. While your flat panel TV attempts to wake the server, a dialog screen appears. If the server is not WOL-compliant or the WOL function fails, a notice appears on the Server List screen.
- 3) Press **EXIT** or **HMG** to exit Home Media Gallery.

Reset to Default

Occasionally it may be easier to return your flat panel TV to the HMG default values rather than try to correct a large number of accidental entries. To restore default settings within the Home Media Gallery, follow the steps below.

- 1) Access *Default Settings* through the *HMG Setup*.
- 2) Select *Yes*.
The default values return and the Home Media Gallery screen appears.
- 3) Press **EXIT** or **HMG** to exit Home Media Gallery.

5.10 Other useful functions

Screen Saver

During navigation, the screen saver launches automatically if no activity is sensed within five minutes. However, when a movie or slideshow is playing, the panel stops the screen saver from activating.

Press any button to cancel the screen saver. Dismissing the screen saver does not interfere when connecting a USB device.

*Note: Pressing **DISPLAY** to show the Player status or key guide before the screen saver activates may cause image retention.*

🚫 Important

- **Do not display the Player status and key guide for an extended period of time while playing a movie or slideshow to avoid possible image retention.**

Dialog Screen Message

No.	Message	Problem
001	Content cannot be played. (001)	No details are available for the error, please check content
100	A communication error occurred. (100)	No further details are available for the error
101	No response from server. (101)	Flat Panel TV timed out due to delayed server response
102	Disconnected from the network. (102)	Cables are disconnected
103	Response from server indicating that it is impossible to reply. (103)	Server response is not understandable
300	Content cannot be played. (300)	No further details are available for the error
301	This format is not supported. (301)	An unsupported file is selected
500	Failed to authenticate. (500)	Failed to obtain DRM authorization
501	Failed to authenticate. (501)	Failed to obtain DRM authorization
502	Failed to authenticate. Check for failure of router, hub, other network devices. (502)	Failed to obtain DRM authorization
503	Failed to authenticate content. The copyright notice of this file might be invalid. (503)	Failed to obtain DRM authorization
504	Failed to authenticate. (504)	Failed to obtain WMDRM authorization
505	Failed to authenticate. Check for failure of router, hub, other network devices. (505)	Failed to obtain WMDRM authorization
506	Failed to authenticate. The max count of access devices depends on server. (506)	Failed to obtain WMDRM authorization
507	Failed to authenticate. The license of this file might be invalid. Receive the license from a server. (507)	Failed to obtain WMDRM authorization
508	Failed to authenticate. (508)	Authorization error other than above

Important

- *Displaying pictures in the Home Media Gallery for an extended period may cause an after-image.*

5.11 Add Other Audio Equipment

The flat panel TV's digital audio output terminal (optical) can output Dolby Digital signals. Using an optical digital cable, connect an AV receiver to the digital audio output terminal (optical) on the rear of the flat panel TV. This connection allows audio such as from digital TV broadcasts to play back in high quality.

If your AV receiver does not have a digital audio input terminal (optical), connect the AUDIO OUT terminals (AUDIO) on the rear of the flat panel TV to the audio input terminals on the AV receiver. However, this method may result in audio delay between the speakers and the sound from the AV receiver. To reduce the delay, mute the speakers on the flat panel TV. Nonetheless, you may still experience some delay between the sound and the picture.

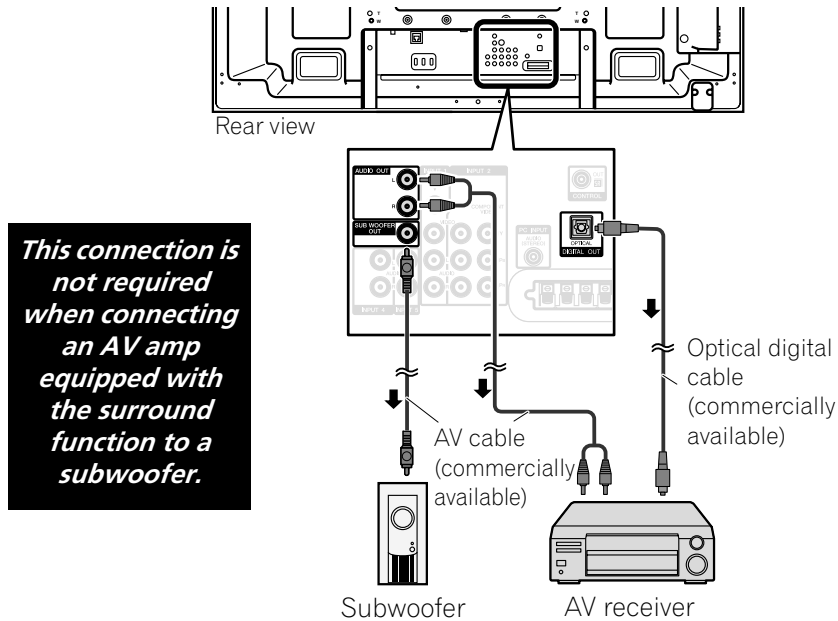

Audio signals synchronized with currently displayed images are output to the AUDIO OUT terminals. However, audio accompanying the images are output to the SUB WOOFER OUT terminal.

When using the digital audio output terminal (optical), select settings according to your AV Receiver. For more information, see the operating instructions that came with the AV Receiver.

Note: When signals are input from the HDMI terminals, no signals are output from the DIGITAL OUT terminal if they are copy guarded.

To set the DIGITAL OUT terminal (OPTICAL) for your AV Receiver, follow the steps below.

- 1) Access the *System Setup* through the *Setup*.
- 2) Select *Digital Audio Output* from the System Setup menu.
- 3) Select an option from the submenu.

Option	Description
Dolby Digital	outputs in Dolby Digital for the Dolby format and outputs in PCM for the PCM format (default)
PCM	outputs in the PCM format regardless of signal type

- 4) Press **HOME MENU** to exit the menu.

5.12 Add a Computer (PC)

Use the panel's PC terminals to connect a personal computer. The PC input terminals are DDC2B-compatible; however, the Plug & Play function may not operate properly. When connected to a PC, the panel automatically identifies the input signal type. If the panel fails to see the PC or the picture is unclear, activate the Auto Setup function.

5.12.1 Automatic Image Position and Clock Adjustments

When connected to a PC, the image position and clock frequency can be adjusted. The Auto Setup option automatically adjusts these options but the image position and clock can be adjusted manually too. This section covers the automatic setup function and the following section covers how to manually adjust image position and clock.

The AV source device must be connected to the flat panel TV and turned on for these options to work. To use Auto Setup to automatically adjust image position and clock, follow the steps below.

- 1) Access the *Option* through the *Setup*.
- 2) Select *Auto Setup* from the Option menu.
The function begins as soon as the selection is made. However, depending on the image, the position may not change after an adjustment.
- 3) Press **HOME MENU** to exit the menu.

Note: This function is unavailable when the PC is connected to the HDMI terminal.

When Auto Setup finishes, the message, "Auto Setup Completed" appears on screen. However, if the setup fails to adjust the image, the message still appears if other factors affect the change. Auto Setup may fail with a PC image composed of similar patterns or a monochrome picture. If Auto Setup fails to correct the image position and clock, change the PC image and try again.

5.12.2 Manual Image Position and Clock Adjustments

Usually Auto Setup for a PC is the best practice for adjusting the image position and clock. However, to personally optimize the image position and clock, follow the steps below.

- 1) Access the *Option* through the *Setup*.
- 2) Select *Manual Setup* from the Option menu.
- 3) Select an option to adjust.



- 4) Use the up/down arrow buttons (↑/↓) to adjust the option.
Clock and Phase also accept the left/right arrows (←/→) for changes.
- 5) Press **HOME MENU** to exit the menu.

6 Helpful Information

This chapter includes answers to some common questions and provides information about software/hardware used in your flat panel TV, cleaning methods, and troubleshooting/service information. If you need further assistance, please contact us and give us the chance to correct any issues you are experiencing. Thank you again for buying Pioneer!

6.1 Frequently Asked Questions (FAQs)

This section answers some of the questions received by our Support staff members. If your question is not here or you would like more information please see the Pioneer website for more FAQs (www.pioneerelectronics.com) about your specific model or our flat panel TVs in general.

Why won't the remote control buttons control my flat panel TV?

If you select the mode other than TV on the remote control, your flat panel TV cannot receive the commands. Press the **SELECT** button to toggle the modes until the TV indicator lights.

Why do I have to move closer to the panel to use the remote control?

Weak batteries in the remote control can cause communication to fail. Try moving closer to the panel and attempt to control the panel with the remote. If the panel responds then change the batteries. If moving closer has no effect on the panel, check the surroundings for objects that might be blocking the signal. Also consider if other equipment that use remote controls have been added to the area around the panel. Objects and other IR signals can disrupt the remote.

How can I protect the remote so it holds up longer?

There are several ways to protect your remote control. Do not leave the remote sitting in direct sunlight as this can warp or deform the case. Avoid spilling liquids on the remote but if this happens, dry it immediately. If necessary, remove the batteries and allow the unit to dry completely before attempting to use it again. Areas with high humidity can also cause damage.

Another issue that can affect the remote control is a leaking battery. The chemicals from a leaky battery can discolor or damage the remote. If there is visible leakage in a battery, remove both batteries immediately and carefully wipe the battery compartment clean. Replace both batteries with fresh ones.

Can the signal from my panel's remote mess up other audio/video equipment?

The flat panel TV emits very weak infrared rays from its screen. If there is other equipment close by that also uses a remote control such as a DVR or stereo system, it may not receive commands from its remote control properly. Try moving the equipment farther away from the flat panel TV.

Note: The strength of infrared rays emitted from the panel differs as the picture changes on the screen.

Why does the picture seem to dim when I leave a picture on the screen?

When still images (such as photos and computer images) stay on the screen for an extended period of time, the screen slightly dims. This function protects the panel from damage by automatically adjusting the screen brightness. The screen dims when a still image is detected for approximately three minutes.

How do I find (or change) the Parental Control password if I forgot it?

To clear a forgotten password, from an "Enter Password" window, press and hold the **ENTER** button on the remote control for three or more seconds. This action resets the password to the default value of 1234. To set a new password, refer to "3.5.1 Assign a Parental Control (Block) Password."

The picture and/or sound on a channel coming through the antenna doesn't seem as clear as it should be, what can I do?

Channels received through an antenna may have a weaker signal. To check signal strength, refer to "Check the Signal Strength" in Section 6.4.1 for more information.

Why is the picture cropped when I feed a PC signal through the PDP-6020FD/5020FD's HDMI input?

If you select *Video* for Signal Type in the HDMI Input menu, the image is over-scanned (enlarged) but the panel automatically switches to *PC* when receiving computer signals. Refer to "5.2.1 Specify the HDMI Input Type."

Why won't my Pioneer flat panel TV turn on?

It may be that your remote has failing batteries or has been damaged. Check the power cord connection at the wall and on the back of the panel. Also try pressing  on your panel.

Why does the blue or red power light on my flat panel TV blink?

The panel's internal protection circuit may have been activated for some reason. First turn the panel's  off, wait one (1) or more minutes, then turn it back on. If the light still blinks, unplug the power cord from the outlet. Plug in the panel again after one to two minutes. If this fails to solve the problem, contact your dealer or Pioneer Customer Support (see inside back cover).

What can I do to prevent image retention or burn-in?

Burn-in or Image Retention is a side effect of plasma technology. After an image remains on the display for an extended time period, when the image changes or the unit is turned off, a faint afterimage or ghost of the original picture may remain. Continuing to play video or leaving the unit turned off for a length of time can clear the afterimage. We recommend the following steps and settings to prevent image retention or burn-in.

- Set Screen Protection to *On*.
- Select *PC* for a signal type when using a PC through an HDMI input.

How do I clean my flat panel TV?

To clean the screen surface, gently wipe it with the supplied dry cloth. Rubbing hard on the screen can scratch the special film coating. Use a clean soft cloth (cotton or flannel, for example) for the TV cabinet. For details on cleaning, refer to "6.3 Cleaning Methods."

6.2 Check Your Software/Hardware Version

You can check the version of all software and hardware used in your flat panel TV. To access the version information, follow the directions below.

- 1) Access the *System Setup* through the *Setup*.
- 2) Select *Technical Info.* from the System Setup menu.
Software and hardware versions appear.
- 3) Press **HOME MENU** to exit the menu after checking the versions.

6.3 Cleaning Methods

Before cleaning your flat panel TV, unplug the power cord from the outlet.

When cleaning the screen or the glossy front bezel, gently wipe with a clean, dry cloth such as the supplied cleaning cloth or a similar type of soft cloth (e.g., cotton, flannel, etc.). Avoid a wet or damp cloth as that can let moisture seep into the panel. A dusty or rough-textured cloth (or if you rub too hard), can scratch surfaces.

Note: Do not use liquid cleaners or aerosol cleaners on the screen.

The chassis or cabinet of the panel is mostly composed of plastic. Do not use chemicals such as benzene or paint thinner to clean the cabinet. These chemicals can mar the finish or cause other deterioration. When cleaning the cabinet, use the same type of cloth and method as described for the front bezel.

Note: Do not affix labels, tapes, etc. to any visible location on the flat panel TV. Adhesives can discolor or mar the panel surfaces.





6.4 Troubleshooting & Service Information

General	
Issue	Possible Solutions
No power	<ul style="list-style-type: none"> • Check the connection seating at the wall and panel. • See if the panel's Power On button is turned ON. • Confirm that the remote is set to TV. <i>If the panel indicator lights red, press (⏻) on the remote control or STANDBY/ON on the flat panel TV.</i>
Power suddenly turns off	<ul style="list-style-type: none"> • Confirm that the Sleep Timer did not turn off your flat panel TV. • Check the power control setting. • See if the panel's internal temperature has increased. <i>Clean the vents or remove any blocking objects.</i>
Panel does not operate	<ul style="list-style-type: none"> • External influences such as voltage malfunction, static electricity, etc., may cause improper operation. <i>Unplug the panel from the wall and leave it for two or more minutes. Reconnect and attempt to operate the panel once again.</i>
Remote control does not operate	<ul style="list-style-type: none"> • Check if TV power is off. Press the button when the POWER ON and STANDBY indicators are off. • Confirm that the mode is set to TV. • Examine the remote control sensor on the panel for obstructions that could block the signal. • Check that the remote's batteries are installed properly and hold a charge. <i>Replace with new batteries to verify.</i> • Consider changes in lighting such as stronger or new light sources that may affect the signal.

Picture/Sound	
Issue	Possible Solutions
No picture and sound	<ul style="list-style-type: none"> • Check the antenna connections. • Reseat the cable connections for other equipment. • Confirm that Parental Control is inactive. • Enter the password to temporarily remove Parental Control (block). • Confirm that the panel is set to watch a TV channel instead of an input source.
No picture	<ul style="list-style-type: none"> • Check the picture adjustment settings. <i>Reset to default values if necessary.</i> • Confirm that the connected equipment is installed and programmed properly. • If viewing an image from a PC, confirm that the signal is compatible.
Screen appears dark	<ul style="list-style-type: none"> • Check for any obstacles in front of the Room Light Sensor.
Odd coloring and shades or misaligned images	<ul style="list-style-type: none"> • Review the room lighting for recent changes or different natural lighting sources from windows or doorways. • Check the picture tone and adjust as necessary.
Picture is cut off or runs off screen	<ul style="list-style-type: none"> • Check the screen size for the current channel/input source. • Confirm that the position of the picture is centered.

Picture/Sound	
Issue	Possible Solutions
Picture but no sound	<ul style="list-style-type: none"> • Confirm that the sound is not muted or that the volume is turned down. • When using a video or PC input source, check that the audio terminals are connected.
Sound but no picture	<ul style="list-style-type: none"> • Check if <i>Picture Off</i> is selected from the TOOLS Menu. <i>With this option selected, the screen is deactivated; only audio is output. To restore the screen display, press any button other than VOL +/- or MUTING.</i>
Sound is wrong (one side only or reversed between left and right)	<ul style="list-style-type: none"> • Check if the speaker cable connections have been reversed between the left and right. • Confirm that speaker cables are connected and seated properly. • Check the sound balance and adjust if necessary.
Brightness and color tone on the sides differ from the center	<ul style="list-style-type: none"> • If images in 4:3 mode or letterbox images are displayed for long periods or for shorter periods over several days, an after-image may remain due to burning. <i>Watch images in Full screen as much as possible to avoid this issue.</i> • Change the Brightness Sync. setting to <i>Auto</i>. <i>This function adjusts the brightness of the gray side masks for the brightness of the main image.</i> • Use the Screen Protection function (See "3.6.2 Extend Your Panel Life")
After-image lag	<ul style="list-style-type: none"> • If a bright or still image was on screen for a long period before switching to a darker image, the original image may appear as an after-image or ghost. Try playing another bright image, switching the picture quickly many times, or show a very active scene. • Use the Screen Protection function (See "3.6.2 Extend Your Panel Life") • Display the Video Pattern screen to help reduce after-image lag.

HDMI Control	
Issue	Possible Solutions
HDMI Controls do not function	<ul style="list-style-type: none"> • Check the connections between the panel and the HDMI equipment. • Confirm that the settings for the panel are correct. • Confirm that the equipment is HDMI compliant. • Confirm that settings for the equipment are correct. <i>For details, refer to the operating instructions that came with the equipment.</i>
Error message: <i>"The device cannot be operated. Please check connection"</i>	<ul style="list-style-type: none"> • Check the connections between the panel and the HDMI equipment. • Confirm that settings for the equipment are correct. <i>For details, refer to the operating instructions that came with the equipment.</i>
No picture and sound	<ul style="list-style-type: none"> • Check the connections between the panel and the HDMI equipment. • Confirm that settings for the equipment are correct. <i>For details, refer to the operating instructions that came with the equipment.</i>
No picture	<ul style="list-style-type: none"> • Check the connections between the panel and the HDMI equipment. • Confirm that settings for the equipment are correct. <i>For details, refer to the operating instructions that came with the equipment.</i>
No sound	<ul style="list-style-type: none"> • Check the connections between the panel and the HDMI equipment. • Confirm that settings for the equipment are correct. <i>For details, refer to the operating instructions that came with the equipment.</i> • Check that the AV system is connected to an HDMI terminal and any recorder/player is connected to another HDMI terminal.

Home Media Gallery/NETWORK	
Issue	Possible Solutions
<p>No servers are found.</p> <p>No previously connected server(s) found (items in <i>Select Servers</i> are dimmed).</p> <p>"Failed to acquire a list." appears on the Server List screen.</p>	<ul style="list-style-type: none"> • Confirm that the PC is On and not in Standby or Sleep. (nothing is chosen in <i>Select Servers</i>). When the PC started from "Wake On LAN" (WOL), check if the PC complies with WOL or if the WOL setup is programmed properly in device manager for BIOS or Windows. • Check the physical connections (hub, router, and cable quality). Please use 100BASE-TX for best quality playback and display speed. • Check the logical connections (IP Address setup, DHCP, etc.). Confirm the IP Address is correct if acquired by Auto IP and Firewall setup. Also check if the IP Address is properly acquired with DHCP on the Network Setup screen that follows the HMG Setup menu. • Using two or more application servers on a single PC may cause unstable operation. For proper operation, it is strongly recommended that one application server is used on a single PC. • Check the PC if its media server is running. Restart if necessary. Check if one or more servers are On (this may cause a malfunction). • Check if the PC is operating properly. Reboot the PC after confirming specifications and setup values. • Check the media server setup. If a client is registered manually, the setup procedure may have to be run again. An option "Not Allowed" may be selected for connections. • Check if UPnP (Universal Plug and Play) is enabled on your router. Refer to your router's instruction manual for procedures. • Wait for a short period then select "Update Server List" from the TOOLS Menu. • Check for radio interference when connected using a wireless LAN. Radio interference may cause the connection to fail. • If the above does not solve the problem, try turning TV  off on the remote control unit then turn  on on the flat panel TV.
<p>An available server is selected but cannot be navigated.</p>	<ul style="list-style-type: none"> • Check if the server is correctly set up for file sharing, if the target folder has been deleted, or if one or more folders have been corrupted on the server. • Check if there are too many files in each folder.
<p>A server is arbitrarily selected.</p>	<ul style="list-style-type: none"> • This arbitrary selection happens when the server you used before had been set to display the Media Navigator menu screen (if you reset it, other servers connected are also reset). • When <i>ON</i> is selected for <i>Auto Connection</i> on the HMG Setup menu, the server is automatically accessed if only one server is connected. Use the TOOLS Menu to select the proper server.
<p>File/folder configuration differs from one server to another (strange configuration).</p>	<ul style="list-style-type: none"> • The Media Navigator displays the server contents as classified by the server. • If no information (such as ID3 tag) is contained in the file, files cannot be classified on the server.
<p>A communication error message appears.</p>	<ul style="list-style-type: none"> • Refer to the possible solutions provided previously for "No servers are found." • If the above does not solve the problem, try turning TV  off on the remote control then turn on the flat panel TV's .

Home Media Gallery/PLAYBACK	
Issue	Possible Solutions
Image or sound is interrupted or distorted (Block noise appears).	<ul style="list-style-type: none"> • Check the physical connections (hub, router, cable quality). Please use 100BASE-TX for best quality playback and display speed. • Check if the PC is operating properly. Reboot the PC after confirming specifications and setup values. • Confirm that the file complies to the supported format, bit rate, and/or profile. Also check the file for damage. • When connected by a wireless LAN, verify that the bit rate is sufficient. • Some files that comply with the supported format may not play back or display. • Check if the DRM content was purchased for use with another PC. Your flat panel TV cannot play DRM content if it has been transferred from the PC on which it was purchased to another PC. You can only play DRM content purchased for the PC in use at the time of purchase. Please obtain a new license or use the PC for which the content was purchased. • Check if content on the same server allows multiple client devices (players).
Cannot play or display.	<ul style="list-style-type: none"> • Check the physical connections (hub, router and cable quality). Please use 100BASE-TX for best quality playback and display speed. • Check if the PC is operating properly. Reboot the PC after confirming its specifications and setup. • Check if the file complies to the supported format, bit rate and/or profile. Also check the file for damage. • Check if the leasing contract for the server has expired. • When connected by a wireless LAN, check if the bit rate is sufficient. • Some files that comply with the supported format may not be played back or displayed. • It takes time to capture and display a large-sized image. If this is the case, no operation may be performed. • Check if the DRM content was purchased for use with another PC. With the flat panel TV you cannot play DRM content if it has been transferred from the PC on which it was purchased to another PC. You can only play DRM content purchased for the PC in use at the time of purchase. Please obtain a new license or use the PC for which the content was purchased. • Check if content on the same server is played with multiple client devices (players).

Home Media Gallery/USB	
Issue	Possible Solutions
USB devices are not properly recognized.	<ul style="list-style-type: none"> • Check if the device is Mass Storage Class compliant. • Check if it is connected properly, nothing is damaged (power unit, mode such as Mass Storage mode and media format, etc.). • Check if it contains the supported files. • Check if the speed of the device is sufficient (poor device speed may result in interrupted or delayed display of images due to a bit-rate problem). When using a digital camera that is not Mass Storage Class compliant, insert the Flash Memory card into the multi-card reader. • Confirm that the device is correctly inserted or removed. • No USB hub is supported. When using a home network, connect directly to the device's USB port.

Home Media Gallery/USB	
Issue	Possible Solutions
Image or sound is interrupted or distorted (Block noise appears).	<ul style="list-style-type: none"> • Verify that the file complies with the supported format, bit rate and/or profile. Also check the file for damage. • Some files that comply with the supported format may not play back or display properly. • Check if the device is Mass Storage Class compliant. • Check if it is connected properly, nothing is damaged (power unit, mode such as Mass Storage mode and media format, etc.). • Check if it contains the supported files. • Check if the speed of the device is sufficient (poor device speed may result in interrupted or delayed display of images due to a bit-rate problem). When using a digital camera that is not Mass Storage Class compliant, insert the Flash Memory card into the multi-card reader.
An external device connected to the USB port does not operate.	<ul style="list-style-type: none"> • Check if the device is connectable to the flat panel TV. • Re-insert the USB cable. • For connection, use a USB cable shorter than 5 m. • Check if the USB cable is properly connected. • First turn the power off and then on again to check if the external device works correctly. • Check if the external device works correctly after the USB device is relaunched. • Check if the digital still camera is in viewing mode. • Refer to the instruction manual for the digital still camera.
Photo data stored in a digital still camera cannot be read through USB interface.	<ul style="list-style-type: none"> • Check if the device is connectable to the flat panel TV. • Check if the digital still camera is turned on. • Check if the digital still camera is in viewing mode.

Home Media Gallery/Slide Show	
Issue	Possible Solutions
Slideshow (photo content) doesn't start.	<ul style="list-style-type: none"> • Check if the player is in pause, rotation or zoom mode. If it is, press PLAY or ENTER to start the slideshow.
Next picture does not appear in the slideshow.	<ul style="list-style-type: none"> • The time needed to display a picture may be longer than the time set to display in Slide Show settings. Reduce the picture size using a PC and try again. • Slide Show only displays supported files. If there is only one supported file, that file remains on the screen. No other files appear.

Other	
Issue	Possible Solutions
Panel sounds/noises	<ul style="list-style-type: none"> • Some sounds are appropriate for plasma technology. Examples: fan motor noise, electrical circuit humming, glass panel buzzing, etc.
Brightness on sides of screen are uneven	<ul style="list-style-type: none"> • Display content that completely fills the screen until unevenness is minimized. • Change the AV mode setting.

If the information above fails to solve the issue, please contact a Pioneer-authorized service representative. Do not attempt to service the panel yourself. Opening or removing covers exposes you to possible electrical shock and other dangers as well as possibly voiding your warranty. Request a qualified service professional to check you flat panel TV.

Some situations that require a service professional are as follows:

- panel dropped or damaged
- power cord or plug damaged
- liquid spilled or an object dropped into the panel
- exposed to rain or water
- noticeable abnormality in panel operation

Occasionally a part within the flat panel TV may fail. Verify that your service professional uses only replacement parts specified by Pioneer or by those with the same characteristics and performance as the original parts. Use of unauthorized parts can result in fire, electric shock, or other danger. Upon completion of any service or repair work, request that the service professional perform safety checks to ensure that the product is operating properly. If you need more assistance or have a Service/Parts-related question, please contact the Pioneer Service organization at (800) 421-1625.

6.4.1 Check the Signal Strength

When receiving a TV channel through a UHF/VHF antenna, check the current channel's signal strength. You may use this function only when receiving digital broadcasting signals over air. Follow the steps below to check a channel's signal strength.

- 1) Access the *System Setup* through the *Setup*.
- 2) Select *Digital Tuner Setup* from the System Setup menu.
- 3) Select *Installation* from the Digital Tuner Setup menu.
- 4) Select *Signal Check* from the submenu.
- 5) Select *RF Channel*.
To add the channel(s), select *Add*.
- 6) Select the channel to be checked.
- 7) Adjust the direction of the antenna until the current signal strength reaches as close to the maximum signal strength as possible.

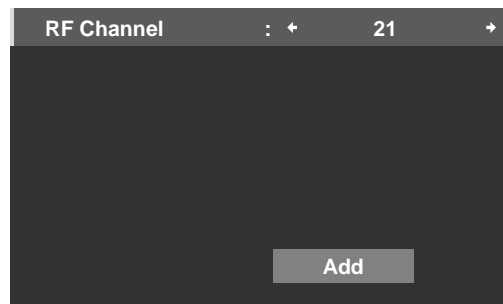

Level : 60%

Quality : 80%

- 8) Press **HOME MENU** to exit the menu.

7 Cautions and Warnings

Your flat panel TV is designed for a long and productive life. To keep your panel at peak performance, there are a few things that can help. This section provides general information and specific warnings to help you maintain the flat panel TV at top quality throughout its lifetime.

Note: If you do not intend to use your flat panel TV for an extended period, occasionally power on and run the panel to maintain functionality.

7.1 Installation Details

It is best to use parts and accessories designed by Pioneer. Use of accessories other than the Pioneer stand or installation bracket may result in instability and could cause injury. For custom installations, please speak with your dealer or expert installer before attempting to install your high-end flat panel TV. These professionals are familiar with proper installation techniques including ventilation.

Using the unit without proper ventilation may cause the internal temperature to rise and could result in a possible malfunction. When the surrounding environmental or internal temperature exceeds a certain degree, the display automatically powers off in order to cool the internal electronics and prevent a hazardous situation.

A malfunction can be caused by a single issue such as ventilation or by a combination of factors. Pioneer is not responsible for accidents or damage caused by using parts and/or accessories manufactured by other companies, inadequate installation sites, poor stabilization practices, erroneous installation methods, operational mistakes, site remodeling, or natural disasters.

For more installation information, refer to the following bullet points:

- Confirm that panel vents are not partially obstructed or completely blocked.
- Use a vacuum cleaner set to its lowest suction setting to clean dusty vents.
- Distance the panel from the wall, other equipment, etc. (for minimum space requirements, refer to "2.1.1 Check the Location for Suitability").
- Do not fit the unit inside of narrow spaces where ventilation is poor.
- Do not drape, seat, or enclose the panel in any material including blankets, loose cloth, or carpeting as this could block the panel vents.
- Use a proper mount or stand rather than leaning the panel against a wall or other support.

7.2 Physical Location & Temperature Considerations

Condensation may form on the surface or inside of the flat panel TV when the panel is moved from a cold place to a warm place or just after a heater or air conditioner is switched on. If condensation forms, do not turn on the flat panel TV until all moisture evaporates. Powering on the display when there is condensation may cause the panel to malfunction.

7.3 Usage Guidelines

For maximum enjoyment of your Pioneer flat panel TV, read the following information carefully.

Over the course of the flat panel TV's lifetime, as with all phosphor-based screens including standard tube-type TVs, the luminosity of the screen diminishes very slowly. Also, static pictures shown over an extended period can adversely affect the screen image. To enjoy bright and beautiful pictures for many years to come, please apply the following guidelines.

- Set the flat panel TV to Standby when it is not being used.
- Avoid leaving a still image or frequently showing the same picture on the screen (e.g. closed-captioned images, games with static portions, etc.).
- Hide the On Screen Display (OSD) from a DVD player, VCR, or other device when not in use.
- Do not leave a picture freeze-framed or paused for long periods.
- Avoid showing a picture with very bright and very dark areas on the screen for extended lengths to time.
- Activate the GAME mode on the AV Selection submenu to play a game but try to limit using this mode for more than two hours at a time.

- View full-motion, high-action video in WIDE or FULL screen after playing a game or showing a still/PC image. The recommended duration for showing the action video is three times as long as the game or PC image was on the screen.
- View full-motion video in WIDE or FULL screen after playing content with side, top, or bottom masking (black bars). Extensive viewing of masked content without this recovery process can cause uneven wear on the plasma cells.

7.4 Signal Interference or Noise

Signal interference, also referred to as *video noise* or *white noise*, can be caused by many different situations. The most common are addressed in the following sections.

Infrared rays

The flat panel TV releases infrared rays because of its characteristics. Depending on how the flat panel TV is used, remote controls for nearby equipment may be adversely affected. Wireless headphones using infrared rays can experience noise interference. If this is the case, move equipment to a location where its remote control sensor is not affected.

Radio Signals

While this flat panel TV meets the required specifications, it can affect the signals for surrounding equipment. If your radio, PC, VCR, or other electrical equipment is disrupted by the panel, move the equipment away from the panel.

Flat Panel TV Motor

The screen of the flat panel TV is composed of extremely fine pixels that emit light according to received video signals. This principle may cause you to hear a slight buzz or electrical hum coming from the panel. This is a normal sound for the flat panel TV and does not indicate a failing unit.

Flat Panel TV Fans

You may hear the sound of a fan motor at times. The slight noise is caused by a cooling fan motor speeding up when the ambient temperature of the flat panel TV rises. This is a normal function of the panel and is not a malfunction.

7.5 Phosphor Properties

The following are typical effects and characteristics of a phosphor-based matrix display and as such are not covered by the Warranty:

- Permanent residual images upon the phosphors of the panel
- Existence of one or more inactive light cells in small quantity
- Noises generated by fan motors, electrical circuits (hum), panel plates, etc.

7.6 Image Information Including Retention & After-Image Lag

Menu Window Size (after a Video Switch)

Programs may be high definition (HD) or standard definition (SD). This flat panel TV automatically scales to the appropriate definition type. If the video program's definition type changes while a menu window is on screen (for example: HD to SD or SD to HD) the menu size may temporarily shrink or enlarge until the panel finishes adjusting the picture. Adjusting may happen, for example, when switching between a TV program and playback from a DVR, or when a recorded program switches between different definition types while the menu is showing. The menu returns to its normal size after a couple of seconds. This action is normal and does not indicate a problem with your flat panel TV.

Pixel Information

Plasma screens show pictures using pixels. Pioneer flat panel TVs contain a very large number of pixels. The size of the panel determines the number of pixels. With the 20FD Series models, there are over 6.2 million pixels in the 50"/60" panel. All Pioneer display panels are manufactured using a very high level of ultra-precision technology and undergo individual quality control.

In rare cases, some pixels can be permanently switched off, or on, resulting in either a black or colored pixel permanently fixed on the screen. This effect is common to all plasma displays because it is a consequence of the technology.

If the defective pixels are visible at the standard viewing distance of between 2.5 and 3.5 meters (8.2 feet and 11.5 feet) while viewing a normal broadcast (i.e. not a test card, still image, or single color display) please immediately contact Pioneer Customer Support (USA) or Customer Satisfaction (CANADA). See inside back cover for contact information. If, however, the faulty pixels can only be seen close up or during single color displays then this is considered normal for this technology.

Image Retention (a.k.a. Burn-In)

Leaving a static picture on screen for several hours can cause a faint imprint of the image. This imprint is known as image retention or burn-in. The image may be temporary or permanent. Although caused by different things, image retention can occur on all display technologies including LDC, plasma, direct view CRT TVs, and projection TVs.

On today's plasma displays, permanent image retention is less of a worry. Most image retention can be improved simply by watching something with a lot of action or rapid screen changes. To avoid image retention as much as possible, refer to the guidelines below.

- Change the picture periodically when showing static images, such as a fixed image from a PC or a TV game unit, for longer periods.
- Avoid leaving fixed images such as time of day indicator or channel logos on screen whenever possible.
- Display content in a wide aspect ratio (no black or gray bars on any side of the content). This flat panel TV is equipped with multiple wide-screen viewing modes; use one of these modes to fill the entire screen with content. View in a wide aspect ratio unless doing so would be a copyright infringement.
- Set the Side Mask detection function to Mode 1 or Mode 2. High Definition 16:9 aspect ratio images containing side masks are detected automatically and side masks are added or the image appears in full-screen.
- Avoid showing dark images after still images for a period of time. In most cases, any image retention caused by this sequence can be corrected by displaying bright images for a similar period of time.

After-Image Lag

Displaying the same images such as still images for a long time may cause after-image lagging. After-Image Lag refers to a ghost of the still image remaining visible after the picture is no longer being shown. This may occur in the following cases.

- After-image lagging due to remaining electric load

If an image with very high peak luminance is displayed for more than a minute, after-image lagging may occur due to the remaining electric load. The ghost-image remaining on the screen disappears when moving images are shown. The luminance of the still image and the length of time it was displayed determine how long it takes for the ghost image to fade away.

- After-image (lag image) due to burning

Avoid displaying the same image on the flat panel TV continuously over a long period. If the same image is displayed continuously for several hours, or for shorter periods over several days, a permanent after-image may remain on the screen. This after-image is permanent because the fluorescent materials burned.

Burned images may fade eventually after playing other video sequences but do not disappear completely.

When a program menu, or frozen image is displayed for up to 10 minutes, the flat panel TV automatically turns the image off to prevent the screen from being burned.

Screen Protection

Screen Protection simultaneously optimizes the related settings to alleviate image retention. For details, see "3.6.2 Extend Your Panel Life."

Image Orbiter

Another built-in feature to protect against burn-in is the Orbiter function. Orbiter automatically changes the position of the picture imperceptibly while the image is on screen. For more information about the feature, refer to "3.6.3 Turn On the Image Orbiter."

7.7 Safety Precautions

Your flat panel TV is engineered and manufactured with one of the highest priorities being safety. However, improper use can result in electric shock and/or fire. To avoid danger please follow the instructions below when installing, operating, and cleaning your flat panel TV.

- Read & Retain Instructions - Read all operating and user information provided with your flat panel TV.
- Environment - Avoid installing the panel in a location with exposure to large quantities of dust, temperature extremes, high humidity, direct sunlight, or subject to excessive vibrations or impact shock. Also, never pour a liquid or insert an object in to the flat panel TV.
- Cleaning - See the section above regarding the proper way to clean your flat panel TV.
- Water & Moisture - Avoid operating or positioning your panel close to water or other sources of liquid. Such locations include a bathroom, a kitchen or laundry sink, in a damp basement, by a swimming pool, etc.
- Power - Turn OFF the panel before connecting any other equipment. Operate the panel only from a grounded outlet.

7.8 Legal Notices

7.8.1 Safety

WARNING

This equipment is not waterproof. To prevent a fire or shock hazard, do not place any container filled with liquid near this equipment (such as a vase or flower pot) or expose it to dripping, splashing, rain or moisture.

D3-4-2-1-3_B_En

WARNING: This product equipped with a three-wire grounding (earthed) plug - a plug that has a third (grounding) pin. This plug only fits a grounding-type power outlet. If you are unable to insert the plug into an outlet, contact a licensed electrician to replace the outlet with a properly grounded one. Do not defeat the safety purpose of the grounding plug.

D3-4-2-1-6_A_En

WARNING: To prevent a fire hazard, do not place any naked flame sources (such as a lighted candle) on the equipment.

D3-4-2-1-7a_A_En

VENTILATION CAUTION:

When installing this unit, make sure to leave space around the unit for ventilation to improve heat radiation. For the minimum space required, see page 15.

WARNING: Slots and openings in the cabinet are provided for ventilation to ensure reliable operation of the product, and to protect it from overheating. To prevent fire hazard, the openings should never be blocked or covered with items (such as newspapers, table-cloths, curtains) or by operating the equipment on thick carpet or a bed.

CAUTION: The ϕ switch on this unit will not completely shut off all power from the AC outlet. Since the power cord serves as the main disconnect device for the unit, you will need to unplug it from the AC outlet to shut down all power. Therefore, make sure the unit has been installed so that the power cord can be easily unplugged from the AC outlet in case of an accident. To avoid fire hazard, the power cord should also be unplugged from the AC outlet when left unused for a long period of time (for example, when on vacation).

D3-4-2-2a_A_En

Operating Environment

Operating environment temperature and humidity:

+0 °C to +40 °C (+32 °F to +104 °F); less than 85 %RH (cooling vents not blocked)

Do not install this unit in a poorly ventilated area, or in locations exposed to high humidity or direct sunlight (or strong artificial light)

D3-4-2-1-7c_A_En

7.8.2 Radio Interference

This digital television is capable of receiving analog basic, digital basic and digital premium cable television programming by direct connection to a cable system providing such programming. A security card provided by your cable operator is required to view encrypted digital programming. Certain advanced and interactive digital cable services such as video-on-demand, a cable operator's enhanced program guide and data-enhanced television services may require the use of a set-top box. For more information call your local cable operator.

Information to User

Alteration or modifications carried out without appropriate authorization may invalidate the user's right to operate the equipment.

D8-10-2_En

[For Canadian model]

This Class B digital apparatus complies with Canadian ICES-003.

D8-10-1-3_En

FEDERAL COMMUNICATIONS COMMISSION DECLARATION OF CONFORMITY

This device complies with part 15 of the FCC Rules. Operation is subject to the following two conditions: (1) This device may not cause harmful interference, and (2) this device must accept any interference received, including interference that may cause undesired operation.

Product Name: Flat Panel TV

Model Number: PDP-6020FD/PDP-5020FD

Product Category: Class B Personal Computers & Peripherals

Responsible Party Name: PIONEER ELECTRONICS SERVICE, INC.

Address: 1925 E. DOMINGUEZ ST., LONG BEACH, CA 90801-1760, U.S.A.

Phone: 800-421-1625

URL: <http://www.pioneerelectronics.com>

NOTE: This equipment has been tested and found to comply with the limits for a Class B digital device, pursuant to Part 15 of the FCC Rules. These limits are designed to provide reasonable protection against harmful interference in a residential installation. This equipment generates, uses, and can radiate radio frequency energy and, if not installed and used in accordance with the instructions, may cause harmful interference to radio communications. However, there is no guarantee that interference will not occur in a particular installation. If this equipment does cause harmful interference to radio or television reception, which can be determined by turning the equipment off and on, the user is encouraged to try to correct the interference by one or more of the following measures:

- Reorient or relocate the receiving antenna.
- Increase the separation between the equipment and receiver.
- Connect the equipment into an outlet on a circuit different from that to which the receiver is connected.
- Consult the dealer or an experienced radio/TV technician for help.

D8-10-1-2_En

CAUTION: This product satisfies FCC regulations when shielded cables and connectors are used to connect the unit to other equipment. To prevent electromagnetic interference with electric appliances such as radios and televisions, use shielded cables and connectors for connections.

D8-10-3a_En

8 Appendix

8.1 Ratings Charts (for Various Audience Classifications)

The charts below list the various rating systems recognized by your flat panel TV.

8.1.1 TV Ratings (age-based)

Rating	Description
TV-Y	All children
TV-Y7	Children seven and above
TV-G	General audiences
TV-PG	Parental guidance suggested
TV-14	Parents strongly cautioned
TV-MA	Mature audiences only

8.1.2 U.S. TV Parental Guideline Ratings (age/category-based)

Rating	Description
FV	Fantasy Violence
V	Violence
S	Sexual Situations
L	Adult Language
D	Sexual Dialog

8.1.3 MPAA Movie Ratings (age-based)

Rating	Description
N/A	Not applicable for MPAA ratings
G	General audiences. All ages admitted.
PG	Parental guidance suggested. Some material may not be suitable for children.
PG-13	Parents strongly cautioned. Some material may be inappropriate for children under 13.
R	Restricted. Under 17 requires accompanying parent or adult guardian (age varies in some jurisdictions).
NC-17	No one 17 and under admitted.
NR	Not rated

8.1.4 Canadian - English Ratings (age-based)

Rating	Description
E (exempt)	News, sports, documentaries, other information programming, talk shows, music videos, variety programming
C (children)	For younger children under the age of eight years; pays close attention to themes that could threaten their sense of security and well-being
C8+ (children over 8)	Contains no portrayal of violence as the preferred, acceptable, or only way to resolve conflict; nor encourages children to imitate dangerous acts they may see on the screen
G (general)	Acceptable for all age groups; contains very little violence, physical, verbal or emotional
PG (parental guidance)	For general audience but may not be suitable for younger children (under the age of eight); could contain controversial themes or issues
14+ (children over 14)	Contains themes where violence is one of the dominant elements of the storyline but it must be integral to the development of plot or character; language usage could be profane; limited nudity present within the context of the theme
18+ (adults)	Contains depictions of violence related to the development of plot, character or themes intended for adult viewing; could contain graphic language and portrayals of sex and nudity

8.1.5 Canadian - French Ratings (age-based)

Rating	Description
E	News, sports, documentaries, other information programming, talk shows, music videos, variety programming
G	All ages and children, contains minimal direct violence, but may be integrated into the plot in a humorous or unrealistic manner
8ans+	General but inadvisable for young children; may be viewed by a wide public audience but could contain scenes disturbing to children under eight who cannot distinguish between imaginary and real situations; view with parent
13ans+	Contains scenes of frequent violent scenes and therefore recommended for viewing with parent
16ans+	Contains frequent violent scenes and intense violence
18ans+	Only for adult viewing; contains frequent violent scenes and extreme violence

8.2 Manufacturer Codes to Program into the Remote Control

8.2.1 Cable

Brand/Code	Brand/Code	Brand/Code	Brand/Code	Brand/Code	Brand/Code
<u>A-Mark</u> 0008,0144	<u>Century</u> 0008	<u>GMI</u> 0883	<u>Pace</u> 1877, 0877,	<u>Regal</u> 0276	<u>Torx</u> 0003
<u>ABC</u> 0237, 0003, 0008	<u>Clearmaster</u> 0883	<u>GoldStar</u> 0144	0237, 0008	<u>Runco</u> 0000	<u>Toshiba</u> 0000
<u>Accuphase</u> 0003	<u>ClearMax</u> 0883	<u>Hitachi</u> 0003, 0008	<u>Panasonic</u> 0144, 0107	<u>Samsung</u> 0003, 0144, 0023	<u>Tristar</u> 0883
<u>Acorn</u> 0237	<u>Cool Box</u> 0883	<u>Insight</u> 0476, 0810	<u>Paragon</u> 0000, 0008, 0525	<u>Scientific</u> 1877, 0877,	<u>United Cable</u> 0276, 0003
<u>Action</u> 0237	<u>Coolmax</u> 0883	<u>Jerrold</u> 0276, 0003	<u>Penney</u> 0000	<u>Atlanta</u> 0477, 0237,	<u>US Electronics</u> 0276, 0003, 0008
<u>Active</u> 0237	<u>Digeo</u> 1187	<u>Memorex</u> 0000	<u>Philips</u> 1305, 0317	0003, 0000, 0008	<u>V2</u> 0883
<u>Americast</u> 0899	<u>Director</u> 0476	<u>Mitsubishi</u> 0003	Pioneer 1877, 0877, 0144, 0533, 0023, 0260, 1021	<u>Sony</u> 1006	<u>Videoway</u> 0000
<u>Archer</u> 0237, 0260	<u>Fosgate</u> 0276	<u>Motorola</u> 1376, 0476, 0810, 0276,	<u>Pulsar</u> 0000	<u>Sprucer</u> 0144	<u>Viewmaster</u> 0883
<u>BCC</u> 0276	<u>GE</u> 0144	1187, 1106	<u>Quasar</u> 0000	<u>Starcom</u> 0003	<u>Vision</u> 0883
<u>Bell South</u> 0899	<u>General</u> 0476, 0810, 0276, 0003	<u>Multitech</u> 0883	<u>RadioShack</u> 0883	<u>Supercable</u> 0276	<u>Vortex View</u> 0883
<u>British Telecom</u> 0003	<u>Instrument</u> 0276, 0003	<u>Nova Vision</u> 0008	<u>RCA</u> 1256	<u>Supermax</u> 0883	<u>Zenith</u> 0000, 0525, 0899
	<u>Gibraltar</u> 0003	<u>Novaplex</u> 0008		<u>Thomson</u> 1256	

8.2.2 Satellite

Brand/Code	Brand/Code	Brand/Code	Brand/Code	Brand/Code	Brand/Code
<u>Bell ExpressVu</u> 0775, 1170	<u>Dishpro</u> 1505, 0775, 1775	<u>HTS</u> 0775, 1775	<u>Mitsubishi</u> 0749	<u>Proscan</u> 0392, 0566	<u>Star Trak</u> 0869
<u>Chaparral</u> 0216	<u>Echostar</u> 1505, 0775, 1170, 1775	<u>Hughes</u> <u>Network</u> <u>Systems</u>	<u>Motorola</u> 0869, 0856	<u>RadioShack</u> 0566, 0775, 0869	<u>Thomson</u> 0392, 0566
<u>Coolsat</u> 1806, 2147	<u>Expressvu</u> 0775, 1775	1142, 0749, 1749, 1442, 1443, 1444, 1538	<u>Netsat</u> 0099	<u>RCA</u> 0392, 0566, 1142, 0775, 0855, 0143, 1392, 1442	<u>TiVo</u> 1142, 1442, 1443, 1444, 1538
<u>Crossdigital</u> 1109	<u>Fortec Star</u> 1550, 1821, 1948	<u>Humax</u> 1790, 1781	<u>Next Level</u> 0869	<u>Panasonic</u> 0247, 0701	<u>Toshiba</u> 0749, 1749, 0790, 0819, 1285
<u>DirecTV</u> 1377, 0392,0566, 0639, 1639, 1142, 0247, 0749, 1749, 0819, 1856, 1076, 1108, 0099, 1109, 1392, 1414, 1442, 1443, 1444, 1538, 1609	<u>Funai</u> 1377	<u>Innova</u> 0099	<u>Pansat</u> 0647, 1807	<u>Pansat</u> 0647, 1807	<u>UltimateTV</u> 1392
<u>Dish Network</u> <u>System</u> 1505, 0775, 1170, 1775	<u>GE</u> 0392, 0566	<u>Jerrold</u> 0869	<u>Philips</u> 1142, 0749, 1749, 0775, 0819, 1076, 0722, 0099, 1442	<u>Samsung</u> 1377, 1142, 1276, 1108, 1109, 1442, 1609	<u>Ultrasat</u> 1806
	<u>General</u> <u>Instrument</u> 0869	<u>JVC</u> 0775, 1170, 1775	<u>Pioneer</u> 1142, 0329, 1442	<u>Sanyo</u> 1219	<u>Uniden</u> 0722
	<u>GQI</u> 0775, 1775	<u>LG</u> 1226, 1414	<u>Primestar</u> 0869	<u>SKY</u> 0856, 0099	<u>Voom</u> 0869
	<u>Hitachi</u> 0749, 0819, 1250	<u>Magnavox</u> 0722		<u>Sony</u> 0639, 1639	<u>Zenith</u> 0856, 1856, 1810
	<u>Houston</u> 0775	<u>McIntosh</u> 0869		<u>Star Choice</u> 0869	

8.2.3 VCR (Brands A - F)

Brand/Code	Brand/Code	Brand/Code	Brand/Code	Brand/Code	Brand/Code
<u>A-Mark</u> 0037, 0240, 0000, 0278, 0046	<u>Allegro</u> 0039, 1137	<u>Bell ExpressVu</u> 1944	<u>Classic</u> 0037	<u>Daytron</u> 0037, 0278	<u>Electroponic</u> 0037
<u>ABS</u> 1972	<u>America Action</u> 0278	<u>Broksonic</u> 0184, 0121,	<u>Colortyme</u> 0060, 0035,	<u>DBX</u> 0040, 0050	<u>Emerald</u> 0184, 0121
<u>Accurian</u> 0000	<u>American High</u> 0035, 0081	0209, 0002, 0479, 1815	0045, 0278	<u>Dell</u> 1972	<u>Emerex</u> 0032
<u>Admiral</u> 0060, 0048, 0039, 0047, 0104, 0209, 0479	<u>Amstrad</u> 0000	<u>Calix</u> 0037	<u>Colt</u> 0000, 0072	<u>Denon</u> 0081, 0042	<u>Emerson</u> 0037, 0184,
<u>Adventura</u> 0037, 0240, 0000	<u>Anam National</u> 0226	<u>Candle</u> 0037, 0038	<u>Craig</u> 0037, 0047, 0240, 0072	<u>Derwent</u> 0041	0240, 0000, 0121, 0043,
<u>Adyson</u> 0072	<u>Asha</u> 0240	<u>Canon</u> 0035	<u>Criterion</u> 0000, 0072	<u>DirectTV</u> 0739, 0740	0209, 0002, 0278, 0479,
<u>Aiko</u> 0278	<u>Astra</u> 0035, 0240	<u>Capehart</u> 0002	<u>Crosley</u> 0035, 0081, 0000	<u>Dish Network</u> System	0593, 1593
<u>Aiwa</u> 0037, 0000, 0124, 0307, 1137, 0468	<u>Audio Dynamics</u> 0040	<u>Captive Works</u> 2167	<u>Crown</u> 0072, 0278	1944	<u>ESA</u> 1137
<u>Akai</u> 0041, 0175	<u>Audio-Technica</u> 0058	<u>Carrera</u> 0240	<u>Curtis Mathes</u> 0060, 0035, 0162, 0240,	<u>Dishpro</u> 1944	<u>Expressvu</u> 1944
<u>Alba</u> 0209, 0072, 0278	<u>Audiovox</u> 0037, 0278, 0038	<u>Carver</u> 0035, 0081	0000, 0041, 0278, 0432	<u>Dual</u> 0000	<u>Fisher</u> 0039, 0047, 0000, 0104, 0046
<u>Alienware</u> 1972	<u>Avis</u> 0000, 0072	<u>CCE</u> 0072, 0278	<u>Cybernex</u> 0240	<u>Dumont</u> 0040	<u>Fuji</u> 0035, 0033
	<u>Beaumarck</u> 0240	<u>Cineral</u> 0278	<u>CyberPower</u> 1972	<u>Durabrand</u> 0039, 0038	<u>Fujitsu</u> 0000
	<u>Bell & Howell</u> 0035, 0048, 0039, 0000, 0104, 0046, 0479	<u>CineVision</u> 1137	<u>Daewoo</u> 0037, 0045, 0278, 0046, 1137	<u>Dynatech</u> 0240, 0000	<u>Funai</u> 0037, 0000, 0072, 0278, 0593, 1593
		<u>Citizen</u> 0035, 0037, 0240, 0000, 0209, 0278, 0479		<u>Echostar</u> 1944	
				<u>Electrohome</u> 0060, 0037, 0240, 0000, 0043, 0209	

8.2.4 VCR (Brands G - O)

Brand/Code	Brand/Code	Brand/Code	Brand/Code	Brand/Code	Brand/Code
<u>Garrard</u> 0000	<u>Headquarter</u> 0046	<u>Jensen</u> 0067, 0041	<u>M Electronic</u> 0240	<u>Metz</u> 0037	<u>NEC</u> 0104, 0067,
<u>Gateway</u> 1972	<u>Hewlett</u> <u>Packard</u> 1972	<u>JVC</u> 0067, 0041,	<u>Magnasonic</u> 0037, 0240,	<u>MGA</u> 0060, 0240,	0041, 0038,
<u>GE</u> 0060, 0035,	<u>HI-Q</u> 0035, 0047,	0058, 1162	0000, 0072,	0043	0040, 0050
0048, 0240,	0000	1944	0278, 0593	<u>MGN</u> <u>Technology</u> 0240	<u>New Tech</u> 0072
0000	<u>Hitachi</u> 0035, 0037,	<u>KEC</u> 0037, 0278	<u>Magnavox</u> 0035, 0037,	<u>Microsoft</u> 1972	<u>Nikko</u> 0037, 0278
<u>Gemini</u> 0060	0045, 0000,	<u>Kenwood</u> 0067, 0041,	0048, 0039,	<u>Midland</u> 0240	<u>Nikkodo</u> 0037, 0278
<u>Genexxa</u> 0037, 0000,	0042, 0041,	0038, 0046	0081, 0240,	<u>Mind</u> 1972	<u>Nishi</u> 0240
0278	0089	<u>KLH</u> 0072	0000, 0226,	<u>Minolta</u> 0042	<u>Niveus Media</u> 1972
<u>Go Video</u> 0240, 0432,	<u>Howard</u> <u>Computers</u> 1972	<u>Kodak</u> 0035, 0037	0563, 0593,	<u>Mitsubishi</u> 0060, 0048,	<u>Noblex</u> 0240
0526, 0614,	<u>HP</u> 1972	<u>KTV</u> 0000	0618, 1593	0047, 0000,	<u>Northgate</u> 1972
1137, 1873	<u>HTS</u> 1944	<u>LG</u> 0037, 0240,	<u>Magnin</u> 0240	0042, 0067,	<u>Olympus</u> 0035, 0162,
<u>GOI</u> 1944	<u>Hughes</u> <u>Network</u> <u>Systems</u> 0042, 0739,	0038, 1037,	<u>Marantz</u> 0035, 0081,	0043, 0041,	0104, 0226
<u>GoldStar</u> 0035, 0037,	0740	1137, 2010	0038	0173	<u>Onkyo</u> 0222
0039, 0000,	<u>Humax</u> 0739, 1797,	<u>Linksys</u> 1972	<u>Marta</u> 0037	<u>Motorola</u> 0035, 0048,	<u>Optimus</u> 1062, 0035,
0278, 0038,	1988	<u>Lloyd's</u> 0240, 0000,	<u>Matsui</u> 0037, 0209	1843	0162, 0037,
1137	<u>Hush</u> 1972	0072, 0038,	<u>Matsushita</u> 0035, 0162,	<u>Movie Walker</u> 0072	0048, 0047,
<u>Goodmans</u> 0037, 0081,	<u>Hytek</u> 0047, 0000,	0040	0081, 1162	<u>MTC</u> 0240, 0000,	0240, 0000,
0000, 0072,	0072	<u>Loewe</u> 0081	<u>Media Center</u> <u>PC</u> 1972	0072	0104, 0058,
0278	<u>iBUYPOWER</u> 1972	<u>Logik</u> 0240, 0000,	<u>MEI</u> 0035	<u>MTX</u> 0000	0432, 0593,
<u>Gradiente</u> 0000	<u>Instant Replay</u> 0035, 0226	0072	<u>Memorex</u> 0035, 0162,	<u>Multitech</u> 0039, 0000,	1162
<u>Granada</u> 0081, 0042	0072	<u>Lumatron</u> 0278	0037, 0048,	0072	<u>Orion</u> 0184, 0240,
<u>Grundig</u> 0081, 0226	<u>ITT Nokia</u> 0240, 0041	<u>Luxor</u> 0046	0039, 0047,	<u>NAD</u> 0240, 0104,	0000, 0104,
<u>Harley Davidson</u> 0000	<u>Janeil</u> 0240	<u>LXI</u> 0037, 0000,	0240, 0000,	0058	0121, 0209,
<u>Harman/Kardon</u> 0081, 0038		0042, 0067	0104, 0209,		0002, 0278,
<u>Harvard</u> 0072			0072, 0278,		0479
<u>Harwood</u> 0072			0046, 0307,		
			0479, 1037,		
			1162		

8.2.5 VCR (Brands P - V)

Brand/Code	Brand/Code	Brand/Code	Brand/Code	Brand/Code	Brand/Code
<u>Panama</u>	<u>Proscan</u>	<u>ReplayTV</u>	<u>Shintom</u>	<u>Symphonic</u>	<u>TNIX</u>
0035	0060	0614, 0616	0039, 0240,	0240, 0000,	0037
<u>Panasonic</u>	<u>Protec</u>	<u>Ricavision</u>	0000, 0072	0002, 0593,	<u>Tocom</u>
1062, 0035,	0000, 0072	1972	<u>Shogun</u>	1593	0240
0162, 0000,	<u>Protech</u>	<u>Rio</u>	0240	<u>Systemax</u>	<u>Toshiba</u>
0225, 0226,	0072	1137	<u>Siemens</u>	1972	0240, 0045,
0614, 0616,	<u>Pulsar</u>	<u>Runco</u>	0037, 0104	<u>Tagar Systems</u>	0000, 0043,
1162	0039, 0240,	0039	<u>Signature</u>	1972	0209, 0041,
<u>Penney</u>	0278	<u>Samsung</u>	0060, 0035,	<u>Tandy</u>	1008, 1972,
0035, 0162,	<u>Pulser</u>	0060, 0240,	0037, 0048,	0000, 0104	1996, 1988
0037, 0047,	0240	0045, 0000,	0000, 0046,	<u>Tashiko</u>	<u>Tosonic</u>
0081, 0240,	<u>Quarter</u>	0038, 0432,	0479	0037	0278
0000, 0042,	0046	0739	<u>Singer</u>	<u>Tatung</u>	<u>Totevision</u>
0067, 0038,	<u>Quartz</u>	<u>Samtron</u>	0037, 0240,	0048, 0081,	0037, 0240
0040	0035, 0047,	0240	0072	0000, 0067,	<u>Touch</u>
<u>Pentax</u>	0046	<u>Sanky</u>	<u>Sonic Blue</u>	0041	1972
0042	<u>Quasar</u>	0048, 0039	0614, 0616,	<u>Teac</u>	<u>Trix</u>
<u>Philco</u>	0035, 0162,	<u>Sansui</u>	1137	0000, 0067,	0037
0035, 0081,	0002, 0226,	0240, 0000,	<u>Sonographe</u>	0041	<u>Ultra</u>
0000, 0209,	1162	0067, 0209,	0046	<u>Technics</u>	0045, 0278
0479	<u>RadioShack</u>	0041, 0072,	<u>Sony</u>	0035, 0162,	<u>Unitech</u>
<u>Philips</u>	0035, 0162,	0002, 0479	0035, 0047,	0037, 0000	0240
0035, 0162,	0037, 0048,	<u>Sanyo</u>	0032, 0033,	<u>Teknika</u>	<u>Vector</u>
0048, 0081,	0047, 0240,	0047, 0240,	0000, 0067,	0035, 0037,	0045
0045, 0000,	0000, 0104,	0000, 0104,	0046, 0226,	0000	<u>Vector Research</u>
0209, 0616,	0046, 1037,	0046, 0159,	0275, 0636,	<u>Telecorder</u>	0184, 0038,
0618, 0739,	1162	0479	1032, 1702,	0240	0040
1081, 1181,	<u>Radix</u>	<u>Scott</u>	1703, 1896,	<u>Telefunken</u>	<u>Vextra</u>
1818	0037	0184, 0045,	1972	0041	0072
<u>Pilot</u>	<u>Randex</u>	0121, 0043	<u>Soundmaster</u>	<u>Tevion</u>	<u>Victor</u>
0037	0037	<u>Sears</u>	0000	0479	0067, 0041
Pioneer	<u>RCA</u>	0060, 0035,	<u>Stack 9</u>	<u>Thomas</u>	<u>Video Concepts</u>
0162, 0081,	0060, 0035,	0162, 0037,	1972	0000, 0002	0045, 0040
0042, 0067,	0048, 0240,	0048, 0039,	<u>Star Choice</u>	<u>Thomson</u>	<u>Videomagic</u>
0058, 0168,	0045, 0000,	0047, 0033,	1843	0060, 0041	0037
1337, 1803	0042, 0880,	0045, 0000,	<u>STS</u>	<u>Tisonic</u>	<u>Videosonic</u>
<u>Polk Audio</u>	0058	0042, 0104,	0042	0278	0240, 0000,
0081	<u>Realistic</u>	0067, 0043,	<u>SV2000</u>	<u>TiVo</u>	0072
<u>Portland</u>	0035, 0162,	0209, 0041,	0000, 0072	0618, 0636,	<u>Viewsonic</u>
0278	0037, 0048,	0072, 0046,	<u>SVA</u>	0739, 0740,	1972
<u>Presidian</u>	0047, 0240,	0058	0000	1337, 1944,	<u>Villain</u>
1593	0000, 0104,	<u>Sharp</u>	<u>Sylvania</u>	1996	0000
<u>Profitronic</u>	0121, 0278,	0048, 0047,	0035, 0081,	<u>TMK</u>	<u>Voodoo</u>
0240	0046, 1162	0032, 0000,	0000, 0043,	0240, 0000	1972
		1875	0593, 1593		

8.2.6 VCR (Brands W - Z)

Brand/Code	Brand/Code	Brand/Code	Brand/Code	Brand/Code	Brand/Code
<u>Wards</u>	0042, 0043,	<u>White</u>	<u>World</u>	<u>Yamaha</u>	0278, 0479,
0060, 0035,	0041, 0072,	<u>Westinghouse</u>	0209, 0002,	0041, 0038	1137, 1709
0037, 0048,	0038, 0046,	0000, 0209,	0479	<u>Zenith</u>	<u>ZT Group</u>
0047, 0081,	0058, 0479	0072, 0278,	<u>XR-1000</u>	0037, 0039,	1972
0033, 0240,	<u>Wharfedale</u>	0479	0035, 0240,	0033, 0000,	
0045, 0000,	0593		0000, 0072	0209, 0041,	

8.2.7 PVR

Brand/Code	Brand/Code	Brand/Code	Brand/Code	Brand/Code	Brand/Code
<u>ABS</u> 1972	<u>Echostar</u> 1944	<u>Hughes</u> <u>Network</u> <u>Systems</u> 0739, 0740	<u>Media Center</u> <u>PC</u> 1972	Pioneer 1337, 1803	<u>Tagar Systems</u> 1972
<u>Alienware</u> 1972	<u>Expressvu</u> 1944	<u>Humax</u> 0739, 1972	<u>Microsoft</u> 1972	<u>RCA</u> 0880	<u>TiVo</u> 0618, 0636, 0739, 1337
<u>Bell ExpressVu</u> 1944	<u>Gateway</u> 1972	<u>Hush</u> 1988	<u>Mind</u> 1972	<u>ReplayTV</u> 0614, 0616	0740
<u>Captive Works</u> 2167	<u>Go Video</u> 0614, 1873	<u>iBUYPOWER</u> 1972	<u>Motorola</u> 1843	<u>Samsung</u> 0739	<u>Toshiba</u> 1008, 1972, 1996, 1988
<u>CyberPower</u> 1972	<u>GOI</u> 1944	<u>JVC</u> 1944	<u>Niveus Media</u> 1972	<u>Sharp</u> 1875	<u>Touch</u> 1972
<u>Dell</u> 1972	<u>Hewlett Packard</u> 1972	<u>LG</u> 2010	<u>Northgate</u> 1972	<u>Sonic Blue</u> 0614, 0616	<u>Viewsonic</u> 1972
<u>DirecTV</u> 0739, 0740	<u>Howard</u> <u>Computers</u> 1972	<u>Linksys</u> 1972	<u>Panasonic</u> 0614, 0616	<u>Sony</u> 0636, 1972	<u>Voodoo</u> 1972
<u>Dish Network</u> <u>System</u> 1944	<u>HP</u> 1972		<u>Philips</u> 0618, 0739	<u>Stack 9</u> 1972	<u>Zenith</u> 1709
<u>Dish Pro</u> 1944	<u>HTS</u> 1944		1818	<u>Star Choice</u> 1843	<u>ZT Group</u> 1972
				<u>Systemax</u> 1972	

8.2.8 BD (HD-DVD)

Brand/Code	Brand/Code	Brand/Code	Brand/Code	Brand/Code
<u>LG</u> 0741	<u>Panasonic</u> 1641	Pioneer 2052, 0142	<u>Samsung</u> 0199	<u>Toshiba</u> 1769
<u>Onkyo</u> 1769	<u>Philips</u> 2084	<u>RCA</u> 1769	<u>Sony</u> 1516	

8.2.9 DVD-R

Brand/Code	Brand/Code	Brand/Code	Brand/Code	Brand/Code	Brand/Code
<u>Accurian</u> 0675, 1416	<u>Coby</u> 1086	<u>Go Video</u> 0741, 1158, 1304, 1730	<u>Magnavox</u> 0646, 0675, 1506	<u>Polaroid</u> 1086, 2130	<u>Sharp</u> 0675
<u>Apex Digital</u> 1056	<u>CyberHome</u> 1129, 1502	<u>iLo</u> 1348	<u>Panasonic</u> 0490	<u>Presidian</u> 1738	<u>Sony</u> 1033, 1070, 1431
<u>Aspire Digital</u> 1168	<u>Digital Max</u> 1738	<u>JVC</u> 1275	<u>Philips</u> 0646, 1340	<u>RCA</u> 0522	<u>Sylvania</u> 0675
<u>Astar</u> 1489	<u>Electrohome</u> 2116	<u>LG</u> 0741	Pioneer 0631, 1460, 1475, 1476, 1512	<u>Samsung</u> 0490, 1470	<u>Toshiba</u> 1510, 1588
<u>Broksonic</u> 1419	<u>Funai</u> 0675, 1334	<u>LiteOn</u> 1158, 1416, 1440, 1738		<u>Sensory</u> <u>Science</u> 1158	<u>Zenith</u> 0741
<u>Citizen</u> 2116	<u>Gateway</u> 1073, 1158				

8.2.10 DVD (Brands A - N)

Brand/Code	Brand/Code	Brand/Code	Brand/Code	Brand/Code	Brand/Code
<u>3D LAB</u> 0503, 0539	<u>Bel Canto</u> <u>Design</u> 1571	<u>Cytron</u> 0705	<u>Fisher</u> 0670	<u>IRT</u> 0783	<u>Magnavox</u> 0503, 0539,
<u>Accurian</u> 0675, 1072, 1416, 1737	<u>Blaupunkt</u> 0717	<u>D-Link</u> 1881	<u>Funai</u> 0675, 1268, 1334	<u>Jaton</u> 1078	0646, 0675, 1268, 1354, 1472, 1506
<u>Acoustic</u> <u>Solutions</u> 0730	<u>Blue Parade</u> 0571	<u>Daewoo</u> 0784, 0705, 0770, 0833,	<u>Gateway</u> 1073, 1077, 1158	<u>JBL</u> 0702	<u>Malata</u> 0782, 1159
<u>Adcom</u> 1094	<u>Blue Sky</u> 0695, 0699	0869, 1169, 1172, 1234, 1242, 1441	<u>GE</u> 0522, 0815, 0717	<u>JMB</u> 0695	<u>Marantz</u> 0503, 0539, 0675
<u>Afreey</u> 0698	<u>Bose</u> 2023	<u>Dansai</u> 0770	<u>Go Video</u> 0573, 0744, 0717, 1730,	<u>JSI</u> 1423	<u>McIntosh</u> 1533, 1273
<u>Aiwa</u> 0641	<u>Brandt</u> 0651	<u>Daytek</u> 0872	1304, 1158, 1144, 1099, 1075, 1044,	<u>JVC</u> 0558, 0623, 0867, 1275, 1550, 1602	<u>Medion</u> 0651
<u>Akai</u> 0695, 0705, 0770, 1089	<u>Broksonic</u> 0695, 1419	<u>Decca</u> 0770	0869, 0833, 0783, 0741, 0715	<u>jWin</u> 1049, 1051	<u>McIntosh</u> <u>Memorex</u> 0695, 0831, 1270
<u>Alba</u> 0672, 0717	<u>California Audio</u> <u>Labs</u> 0490	<u>Denon</u> 0490, 0634	<u>Denver</u> 0778	<u>Kawasaki</u> 0790	<u>Microsoft</u> 0522, 1708, 2083
<u>Alco</u> 0790	<u>CAVS</u> 1057	<u>Desay</u> 1407	<u>Go Vision</u> 1072	<u>Kenwood</u> 0490, 0534, 0682, 0737	<u>Minato</u> 0752
<u>Allegro</u> 0869	<u>Celestial</u> 1020	<u>Diamond Vision</u> 1316	<u>GoldStar</u> 0741, 0869	<u>KLH</u> 0717, 0790, 1020, 1149	<u>Mintek</u> 0839, 0717, 1472
<u>Amphion Media</u> <u>Works</u> 0872, 1245	<u>Centrex</u> 0672, 1004	<u>DigitalMax</u> 1738	<u>Goodmans</u> 0790	<u>Kloss</u> 0533	<u>Mitsubishi</u> 1521, 0521
<u>AMW</u> 0872, 1245	<u>Cinea</u> 0831	<u>Digitrex</u> 0672	<u>GPX</u> 0699, 0769	<u>Konka</u> 0711, 0721	<u>Momitsu</u> 1082
<u>Apex Digital</u> 0533, 0672, 0717, 0755, 0794, 0795, 0796, 0797, 1004, 1020, 1056, 1061	<u>Cinego</u> 1399	<u>Disney</u> 0675, 1270	<u>Gradiente</u> 0490, 0651	<u>Koss</u> 0651, 0769, 0896, 1061, 1423	<u>Mustek</u> 0730
<u>Arrgo</u> 1023	<u>CineVision</u> 0876, 0833, 0869	<u>DiViDo</u> 0705	<u>Greenhill</u> 0717	<u>Landel</u> 0826	<u>Myryad</u> 0894
<u>Aspire Digital</u> 1168, 1407	<u>Citizen</u> 1003, 0695, 1277, 1587, 2116	<u>Dual</u> 0675, 1068, 1085	<u>Grundig</u> 0539, 0705	<u>Lasonic</u> 0627, 0798, 1173	<u>NAD</u> 0692, 0741
<u>Astar</u> 1489, 1678, 1679	<u>Clairtone</u> 0571	<u>Durabrand</u> 1127, 2164	<u>Harman/Kardon</u> 0582, 0702	<u>Lecson</u> 1533	<u>Naiko</u> 0770
<u>Audiovox</u> 0717, 0790, 1041, 1072, 1121, 1122	<u>Coby</u> 0778, 0852, 1077, 1086, 1107, 1165, 1177, 1351, 1628	<u>DVD2000</u> 0521	<u>Helios</u> 2080	<u>Lenoxx</u> 1127	<u>Nakamichi</u> 1222
<u>Awa</u> 0730	<u>Electrohome</u> 1003, 2116	<u>Electrohome</u> 1003, 2116	<u>Hello Kitty</u> 0831	<u>LG</u> 0591, 0741, 0869	<u>NEC</u> 0785, 0869
<u>Axion</u> 1072	<u>Emerson</u> 0591, 0675, 1268	<u>Emerson</u> 0591, 0675, 1268	<u>Hitachi</u> 0573, 0664, 1247, 1664	<u>LiteOn</u> 1058, 1158, 1416, 1440, 1656, 1738	<u>Nesa</u> 0717
<u>B & K</u> 0655, 0662	<u>Craig</u> 0831	<u>Enterprise</u> 0591	<u>Hiteker</u> 0672	<u>Loewe</u> 0511, 0741	<u>Next Base</u> 0826
<u>BBK</u> 1224	<u>Creative</u> 0503, 0539	<u>Entivo</u> 0503, 0539	<u>Humax</u> 1588, 1500	<u>Logix</u> 0783	<u>NexxTech</u> 1402
	<u>Curtis Mathes</u> 1087	<u>Enzer</u> 0770	<u>iLo</u> 1348, 1472	<u>Magnasonic</u> 0651, 0675	<u>Nintaus</u> 1051
	<u>CyberHome</u> 0816, 0874, 1023, 1024, 1117, 1129, 1502, 1537	<u>ESA</u> 1268	<u>Initial</u> 0717, 1472		<u>Norcent</u> 1003, 0872, 1107, 1265
		<u>Firstline</u> 0651	<u>Insignia</u> 1268, 2095, 2150		<u>Nova</u> 1517
			<u>Integra</u> 0571, 0627		

8.2.11 DVD (Brands O - Z)

Brand/Code	Brand/Code	Brand/Code	Brand/Code	Brand/Code	Brand/Code
<u>Onkyo</u> 0503, 0627, 1769	<u>Polaroid</u> 1020, 1061, 1086, 1245, 1316, 1478, 2130	<u>Revoy</u> 0699 <u>Rio</u> 0869, 2002	<u>Sharper Image</u> 1117 <u>Sherwood</u> 0633, 0770, 1043, 1077, 1889	1268, 1334 <u>TAG McLaren</u> 0894 <u>Tatung</u> 0770 <u>Teac</u> 0571, 0717, 0692, 0790	<u>Unimax</u> 0770 <u>United</u> 0730 <u>Universum</u> 0591 <u>Urban Concepts</u> 0503, 0539 <u>US Logic</u> 0839 <u>V</u> 1064, 1226 <u>Venturer</u> 0790 <u>Vizio</u> 1064, 1226
<u>Oppo</u> 0575, 1224, 2185	<u>Polk Audio</u> 0539 <u>Portland</u> 0770 <u>Presidian</u> 0675, 1072, 1738	<u>RJTech</u> 0118, 1360 <u>Rotel</u> 0623, 1178 <u>Rowa</u> 0823, 1004 <u>Saba</u> 0651	<u>Shinasonic</u> 0533, 0839 <u>Slim Art</u> 0784 <u>SM Electronic</u> 0730 <u>Sonic Blue</u> 0573, 0715, 0783, 0869, 1099, 2002	<u>Technics</u> 0490, 0703 <u>Technika</u> 0770 <u>Technosonic</u> 0730 <u>Techwood</u> 0692 <u>Terapin</u> 1031 <u>Tevion</u> 0651 <u>Theta Digital</u> 0571 <u>Thomson</u> 0522, 0511 <u>TiVo</u> 1503, 1512, 1588 <u>Toshiba</u> 0503, 0573, 0539, 0695, 1154, 1503, 1510, 1588, 1608, 1769	<u>Wesder</u> 0699 <u>Xbox</u> 0522, 1708, 2083 <u>Yamaha</u> 0490, 0539, 0545, 0497, 0817 <u>Yamakawa</u> 0872 <u>Zenith</u> 0503, 0591, 0741, 0869 <u>Zeus</u> 0784 <u>Zoece</u> 1265
<u>Optimus</u> 0571 <u>OptoMedia</u> <u>Electronics</u> 0896 <u>Oritron</u> 0651 <u>Palsonic</u> 0672, 0852 <u>Panasonic</u> 0503, 0490, 0571, 0703, 1641, 1762 <u>Philco</u> 0675 <u>Philips</u> 0503, 0539, 0646, 0675, 1267, 1340, 1354, 1846, 2056, 2084 <u>Phonotrend</u> 0699 <u>PianoDisc</u> 1024 Pioneer 0525, 0571, 0142, 0631, 1475, 1476, 1571, 1460, 1512, 1902, 2052	<u>Proscan</u> 0522 <u>Prosonic</u> 0699 <u>ProVision</u> 0778 <u>Qwestar</u> 0651 <u>Radionette</u> 0741 <u>RadioShack</u> 0571 <u>RCA</u> 0522, 0571, 0717, 0790, 0822, 1022, 1769 <u>Realistic</u> 0571 <u>Reoc</u> 0752	<u>Samsung</u> 0298, 0490, 0573, 0744, 0199, 0820, 1044, 1075, 1470, 2069 <u>Sansui</u> 0695 <u>Sanyo</u> 0670, 0675, 0695, 0873, 1334 <u>Schneider</u> 0783 <u>Schwaiger</u> 0752 <u>Sensory</u> <u>Science</u> 1158 <u>Sharp</u> 0630, 0675, 0752, 1256	<u>Sony</u> 0533, 0772, 0864, 1033, 1070, 1431, 1516, 1533, 1548, 1633, 1791, 1824, 1892, 1903, 1904, 1934, 2020, 2043 <u>Sova</u> 1122 <u>Sungale</u> 1074 <u>SVA</u> 0717, 0860, 1105 <u>Sylvania</u> 0675, 1268 <u>Symphonic</u> 0675, 0894,	<u>1268, 1334</u> <u>TAG McLaren</u> 0894 <u>Tatung</u> 0770 <u>Teac</u> 0571, 0717, 0692, 0790 <u>Technics</u> 0490, 0703 <u>Technika</u> 0770 <u>Technosonic</u> 0730 <u>Techwood</u> 0692 <u>Terapin</u> 1031 <u>Tevion</u> 0651 <u>Theta Digital</u> 0571 <u>Thomson</u> 0522, 0511 <u>TiVo</u> 1503, 1512, 1588 <u>Toshiba</u> 0503, 0573, 0539, 0695, 1154, 1503, 1510, 1588, 1608, 1769 <u>Tredex</u> 0800, 0803, 0804	<u>Wesder</u> 0699 <u>Xbox</u> 0522, 1708, 2083 <u>Yamaha</u> 0490, 0539, 0545, 0497, 0817 <u>Yamakawa</u> 0872 <u>Zenith</u> 0503, 0591, 0741, 0869 <u>Zeus</u> 0784 <u>Zoece</u> 1265

8.2.12 LD

Brand/Code	Brand/Code	Brand/Code	Brand/Code	Brand/Code	Brand/Code
<u>Carver</u> 0064, 0194, 0323 <u>Denon</u> 0059, 0172, 0241 <u>Disco Vision</u> 0023 <u>Harman/Kardon</u> 0194	<u>Hitachi</u> 0023, 0395 <u>Magnavox</u> 0064, 0194, 0217, 0241 <u>Marantz</u> 0064, 0194 <u>Mitsubishi</u> 0059, 0241	<u>NAD</u> 0059 <u>NEC</u> 0286 <u>Optimus</u> 0059 <u>Panasonic</u> 0204 <u>Philips</u> 0064, 0194	Pioneer 0059, 0023, 0241, 0463, 0572, 1274 <u>Polk Audio</u> 0194 <u>Quasar</u> 0204 <u>Renaissance</u> 0323	<u>Samsung</u> 0323 <u>Sega</u> 0023 <u>Sharp</u> 0001 <u>Sony</u> 0193, 0201, 0270 <u>Technics</u> 0204	<u>Theta Digital</u> 0194 <u>Toshiba</u> 0059 <u>Victor</u> 0245 <u>Wards</u> 0059 <u>Yamaha</u> 0217

8.3 Specifications

Flat Panel TV	PDP-6020FD (60")	PDP-5020FD (50")
Number of pixels	1920 × 1080 pixels	1920 × 1080 pixels
Audio Amplifier	18 W + 18 W (1 kHz, 10 %, 6 Ω)	18 W + 18 W (1 kHz, 10 %, 6 Ω)
Speaker	Woofer: 4.8 cm x 13 cm cone type Tweeter: 2.5 cm semidome type	Woofer: 4.8 cm x 13 cm cone type Tweeter: 2.5 cm semidome type
Sound Effect	SRS FOCUS/SRS/SRS TruBass/ SRS Definition	SRS FOCUS/SRS/SRS TruBass/ SRS Definition
On-Screen Languages	English, French, Spanish	English, French, Spanish
Power Requirement	120 V AC, 60 Hz, 524 W (0.3 W Standby)	120 V AC, 60 Hz, 436 W (0.2 W Standby)
Weight	Main unit: 50.8 kg (112.0 lbs) Stand: 5.3 kg (11.7 lbs)(including bolts) Speaker: 3.7 kg (8.2 lbs) (including cables, mounting fittings and screws) Total: 59.8 kg (131.8 lbs)	Main unit: 33.6 kg (74.1 lbs) Stand: 2.2 kg (4.9 lbs)(including bolts) Speaker: 3.2 kg (7.1 lbs) (including cables, mounting fittings and screws) Total: 39 kg (86 lbs)

Reception System		
Digital		ATSC Digital TV system
	Circuit Type	8VSB/64QAM/256QAM
	Tuner VHF/UHF	VHF Ch. 2 to 13 UHF Ch. 14 to 69
	Tuner CATV	Ch. 2 to 135
	Audio format	Dolby Digital
Analog		American TV standard NTSC system
	Circuit Type	Video signal detection PLL full synchronous detection, PLL digital Synthesizer system
	Tuner VHF/UHF	VHF Ch. 2 to 13 UHF Ch. 14 to 69
	Tuner CATV	Cable Ch. 1 to 135
	Audio multiplex	BTSC system

Terminals - Side		
	INPUT 3	VIDEO in, AUDIO in
	INPUT 7	HDMI in*
	PHONES	16 Ω to 32 Ω recommended
	USB	USB in**

Terminals - Rear		
ANT		75 Ω UNBAL, F Type for DTV/VHF/UHF/CATV in
INPUT 1		S-VIDEO in, VIDEO in, AUDIO in
INPUT 2		COMPONENT VIDEO in, VIDEO in, AUDIO in
INPUT 4		HDMI in*, AUDIO in
PC INPUT		Analog RGB in, AUDIO in
INPUT 5		HDMI in*, AUDIO in
INPUT 6		HDMI in*
AUDIO OUT		AUDIO out (Fixed)
DIGITAL OUT		Optical
ETHERNET		1
CONTROL OUT		1
SPEAKERS		6 Ω to 16 Ω
SUB WOOFER OUT		Variable

* conforms to HDMI1.3 (Deep Color) and HDCP1.1

** conforms to USB 1.1 and 2.0

HDMI (High-Definition Multimedia Interface) is a digital interface that handles both video and audio using a single cable.

HDCP (High-bandwidth Digital Content Protection) is a technology used to protect copyrighted digital contents that use the Digital Visual Interface (DVI).

Note: Design and specifications are subject to change without notice



Dimensions

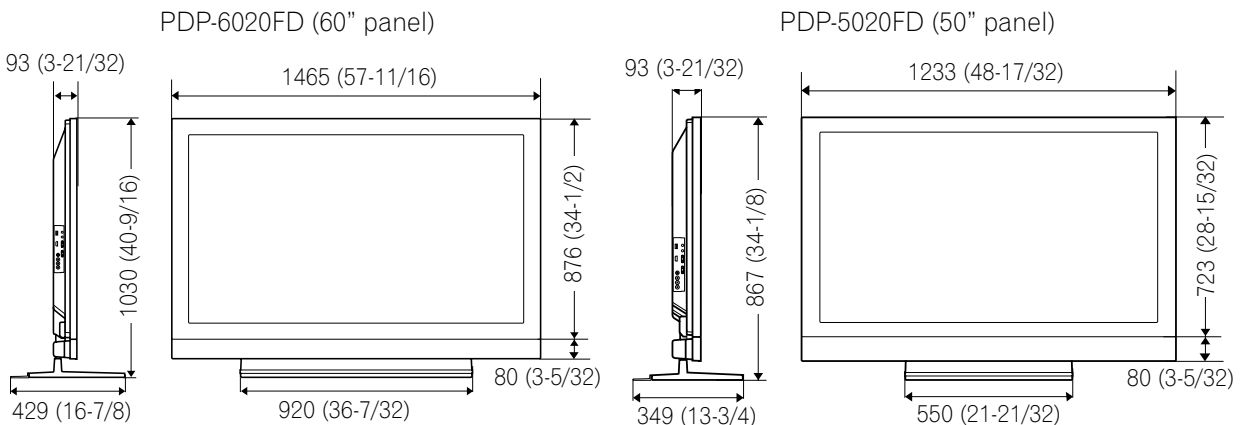

License

[MPEG4IP]

This software is based in part on Mozilla Public License 1.1 see <http://www.mozilla.org/MPL/> for information.

[OpenSSL]

OpenSSL License

Copyright © 1998-2007 The OpenSSL Project. All rights reserved.

Redistribution and use in source and binary forms, with or without modification, are permitted provided that the following conditions are met:

1. Redistributions of source code must retain the above copyright notice, this list of conditions and the following disclaimer.
2. Redistributions in binary form must reproduce the above copyright notice, this list of conditions and the following disclaimer in the documentation and/or other materials provided with the distribution.
3. All advertising materials mentioning features or use of this software must display the following acknowledgment: "This product includes software developed by the OpenSSL Project for use in the OpenSSL Toolkit. (<http://www.openssl.org/>)".
4. The names "OpenSSL Toolkit" and "OpenSSL Project" must not be used to endorse or promote products derived from this software without prior written permission. For written permission, please contact openssl-core@openssl.org.
5. Products derived from this software may not be called "OpenSSL" nor may "OpenSSL" appear in their names without prior written permission of the OpenSSL Project.
6. Redistributions of any form whatsoever must retain the following acknowledgment: "This product includes software developed by the OpenSSL Project for use in the OpenSSL Toolkit (<http://www.openssl.org/>)".

THIS SOFTWARE IS PROVIDED BY THE OpenSSL PROJECT "AS IS" AND ANY EXPRESSED OR IMPLIED WARRANTIES, INCLUDING, BUT NOT LIMITED TO, THE IMPLIED WARRANTIES OF MERCHANTABILITY AND FITNESS FOR A PARTICULAR PURPOSE ARE DISCLAIMED. IN NO EVENT SHALL THE OpenSSL PROJECT OR ITS CONTRIBUTORS BE LIABLE FOR ANY DIRECT, INDIRECT, INCIDENTAL, SPECIAL, EXEMPLARY, OR CONSEQUENTIAL DAMAGES (INCLUDING, BUT NOT LIMITED TO, PROCUREMENT OF SUBSTITUTE GOODS OR SERVICES; LOSS OF USE, DATA, OR PROFITS; OR BUSINESS INTERRUPTION) HOWEVER CAUSED AND ON ANY THEORY OF LIABILITY, WHETHER IN CONTRACT, STRICT LIABILITY, OR TORT (INCLUDING NEGLIGENCE OR OTHERWISE) ARISING IN ANY WAY OUT OF THE USE OF THIS SOFTWARE, EVEN IF ADVISED OF THE POSSIBILITY OF SUCH DAMAGE.

This product includes cryptographic software written by Eric Young (eay@cryptsoft.com). This product includes software written by Tim Hudson (tjh@cryptsoft.com).

Original SSLeay License

Copyright © 1995-1998 Eric Young (eay@cryptsoft.com)

All rights reserved.

This package is an SSL implementation written by Eric Young (eay@cryptsoft.com). The implementation was written so as to conform with Netscapes SSL. This library is free for commercial and non-commercial use as long as the following conditions are adhered to. The following conditions apply to all code found in this distribution, be it the RC4, RSA, lhash, DES, etc., code; not just the SSL code. The SSL documentation included with this distribution is covered by the same copyright terms except that the holder is Tim Hudson (tjh@cryptsoft.com).

Copyright remains Eric Young's, and as such any Copyright notices in the code are not to be removed. If this package is used in a product, Eric Young should be given attribution as the author of the parts of the library used. This can be in the form of a textual message at program startup or in documentation (online or textual) provided with the package.

Redistribution and use in source and binary forms, with or without modification, are permitted provided that the following conditions are met:

1. Redistributions of source code must retain the copyright notice, this list of conditions and the following disclaimer.
2. Redistributions in binary form must reproduce the above copyright notice, this list of conditions and the following disclaimer in the documentation and/or other materials provided with the distribution.
3. All advertising materials mentioning features or use of this software must display the following acknowledgement: "This product includes cryptographic software written by Eric Young (eay@cryptsoft.com)" The word 'cryptographic' can be left out if the routines from the library being used are not cryptographic related:-).
4. If you include any Windows specific code (or a derivative thereof) from the apps directory (application code) you must include an acknowledgement: "This product includes software written by Tim Hudson (tjh@cryptsoft.com)"

THIS SOFTWARE IS PROVIDED BY ERIC YOUNG "AS IS" AND ANY EXPRESS OR IMPLIED WARRANTIES, INCLUDING, BUT NOT LIMITED TO, THE IMPLIED WARRANTIES OF MERCHANTABILITY AND FITNESS FOR A PARTICULAR PURPOSE ARE DISCLAIMED. IN NO EVENT SHALL THE AUTHOR OR CONTRIBUTORS BE LIABLE FOR ANY DIRECT, INDIRECT, INCIDENTAL, SPECIAL, EXEMPLARY, OR CONSEQUENTIAL DAMAGES (INCLUDING, BUT NOT LIMITED TO, PROCUREMENT OF SUBSTITUTE GOODS OR SERVICES; LOSS OF USE, DATA, OR PROFITS; OR BUSINESS INTERRUPTION) HOWEVER CAUSED AND ON ANY THEORY OF LIABILITY, WHETHER IN CONTRACT, STRICT LIABILITY, OR TORT (INCLUDING NEGLIGENCE OR OTHERWISE) ARISING IN ANY WAY OUT OF THE USE OF THIS SOFTWARE, EVEN IF ADVISED OF THE POSSIBILITY OF SUCH DAMAGE.

The licence and distribution terms for any publically available version or derivative of this code cannot be changed. i.e. this code cannot simply be copied and put under another distribution licence [including the GNU Public Licence.]

[tiff]

Copyright © 1988-1997 Sam Leffler

Copyright © 1991-1997 Silicon Graphics, Inc.

THE SOFTWARE IS PROVIDED "AS-IS" AND WITHOUT WARRANTY OF ANY KIND, EXPRESS, IMPLIED OR OTHERWISE, INCLUDING WITHOUT LIMITATION, ANY WARRANTY OF MERCHANTABILITY OR FITNESS FOR A PARTICULAR PURPOSE. IN NO EVENT SHALL SAM LEFFLER OR SILICON GRAPHICS BE LIABLE FOR ANY SPECIAL, INCIDENTAL, INDIRECT OR CONSEQUENTIAL DAMAGES OF ANY KIND, OR ANY DAMAGES WHATSOEVER RESULTING FROM LOSS OF USE, DATA OR PROFITS, WHETHER OR NOT ADVISED OF THE POSSIBILITY OF DAMAGE, AND ON ANY THEORY OF LIABILITY, ARISING OUT OF OR IN CONNECTION WITH THE USE OR PERFORMANCE OF THIS SOFTWARE.

[Howl]

Copyright © 2003, 2004 Porchdog Software All rights reserved.

THIS SOFTWARE IS PROVIDED BY THE COPYRIGHT HOLDERS AND CONTRIBUTORS "AS IS" AND ANY EXPRESS OR IMPLIED WARRANTIES, INCLUDING, BUT NOT LIMITED TO, THE IMPLIED WARRANTIES OF MERCHANTABILITY AND FITNESS FOR A PARTICULAR PURPOSE ARE DISCLAIMED. IN NO EVENT SHALL THE COPYRIGHT OWNER OR CONTRIBUTORS BE LIABLE FOR ANY DIRECT, INDIRECT, INCIDENTAL, SPECIAL, EXEMPLARY, OR CONSEQUENTIAL DAMAGES (INCLUDING, BUT NOT LIMITED TO, PROCUREMENT OF SUBSTITUTE GOODS OR SERVICES; LOSS OF USE, DATA, OR PROFITS; OR BUSINESS INTERRUPTION) HOWEVER CAUSED AND ON ANY THEORY OF LIABILITY, WHETHER IN CONTRACT, STRICT LIABILITY, OR TORT (INCLUDING NEGLIGENCE OR OTHERWISE) ARISING IN ANY WAY OUT OF THE USE OF THIS SOFTWARE, EVEN IF ADVISED OF THE POSSIBILITY OF SUCH DAMAGE.

This software is based in part on Apple Public Source License or the recent's rights thereunder see <http://developer.apple.com/> for information.

[libupnp]

Copyright © 2000-2003 Intel Corporation

All rights reserved.

Redistribution and use in source and binary forms, with or without modification, are permitted provided that the following conditions are met:

* Redistributions of source code must retain the above copyright notice, this list of conditions and the following disclaimer.

* Redistributions in binary form must reproduce the above copyright notice, this list of conditions and the following disclaimer in the documentation and/or other materials provided with the distribution.

* Neither name of Intel Corporation nor the names of its contributors may be used to endorse or promote products derived from this software without specific prior written permission.

THIS SOFTWARE IS PROVIDED BY THE COPYRIGHT HOLDERS AND CONTRIBUTORS "AS IS" AND ANY EXPRESS OR IMPLIED WARRANTIES, INCLUDING, BUT NOT LIMITED TO, THE IMPLIED WARRANTIES OF MERCHANTABILITY AND FITNESS FOR A PARTICULAR PURPOSE ARE DISCLAIMED. IN NO EVENT SHALL INTEL OR CONTRIBUTORS BE LIABLE FOR ANY DIRECT, INDIRECT, INCIDENTAL, SPECIAL, EXEMPLARY, OR CONSEQUENTIAL DAMAGES (INCLUDING, BUT NOT LIMITED TO, PROCUREMENT OF SUBSTITUTE GOODS OR SERVICES; LOSS OF USE, DATA, OR PROFITS; OR BUSINESS INTERRUPTION) HOWEVER CAUSED AND ON ANY THEORY OF LIABILITY, WHETHER IN CONTRACT, STRICT LIABILITY, OR TORT (INCLUDING NEGLIGENCE OR OTHERWISE) ARISING IN ANY WAY OUT OF THE USE OF THIS SOFTWARE, EVEN IF ADVISED OF THE POSSIBILITY OF SUCH DAMAGE.

[JPEG image compression]

If only executable code is distributed, then the accompanying documentation must state that "this software is based in part on the work of the Independent JPEG Group".

[libpng]

COPYRIGHT NOTICE, DISCLAIMER, and LICENSE:

If you modify libpng you may insert additional notices immediately following this sentence. libpng versions 1.2.6, August 15, 2004, through 1.2.25, February 18, 2008, are Copyright © 2004, 2006-2008 Glenn Randers-Pehrson, and are distributed according to the same disclaimer and license as libpng-1.2.5 with the following individual added to the list of Contributing Authors

Cosmin Truta

libpng versions 1.0.7, July 1, 2000, through 1.2.5 - October 3, 2002, are Copyright © 2000-2002 Glenn Randers-Pehrson, and are distributed according to the same disclaimer and license as libpng-1.0.6 with the following individuals added to the list of Contributing Authors

Simon-Pierre Cadieux

Eric S. Raymond

Gilles Vollant

and with the following additions to the disclaimer:

There is no warranty against interference with your enjoyment of the library or against infringement. There is no warranty that our efforts or the library will fulfill any of your particular purposes or needs. This library is provided with all faults, and the entire risk of satisfactory quality, performance, accuracy, and effort is with the user.

libpng versions 0.97, January 1998, through 1.0.6, March 20, 2000, are Copyright © 1998, 1999 Glenn Randers-Pehrson, and are distributed according to the same disclaimer and license as libpng-0.96, with the following individuals added to the list of Contributing Authors:

Tom Lane

Glenn Randers-Pehrson

Willem van Schaik

libpng versions 0.89, June 1996, through 0.96, May 1997, are Copyright © 1996, 1997 Andreas Dilger Distributed according to the same disclaimer and license as libpng-0.88, with the following individuals added to the list of Contributing Authors:

John Bowler

Kevin Bracey

Sam Bushell

Magnus Holmgren

Greg Roelofs

Tom Tanner

libpng versions 0.5, May 1995, through 0.88, January 1996, are Copyright © 1995, 1996 Guy Eric Schalnat, Group 42, Inc.

For the purposes of this copyright and license, "Contributing Authors" is defined as the following set of individuals:

Andreas Dilger
 Dave Martindale
 Guy Eric Schalnat
 Paul Schmidt
 Tim Wegner

The PNG Reference Library is supplied "AS IS". The Contributing Authors and Group 42, Inc. disclaim all warranties, expressed or implied, including, without limitation, the warranties of merchantability and of fitness for any purpose. The Contributing Authors and Group 42, Inc. assume no liability for direct, indirect, incidental, special, exemplary, or consequential damages, which may result from the use of the PNG Reference Library, even if advised of the possibility of such damage.

Permission is hereby granted to use, copy, modify, and distribute this source code, or portions hereof, for any purpose, without fee, subject to the following restrictions:

1. The origin of this source code must not be misrepresented.
2. Altered versions must be plainly marked as such and must not be misrepresented as being the original source.
3. This Copyright notice may not be removed or altered from any source or altered source distribution.

The Contributing Authors and Group 42, Inc. specifically permit, without fee, and encourage the use of this source code as a component to supporting the PNG file format in commercial products. If you use this source code in a product, acknowledgment is not required but would be appreciated.

A "png_get_copyright" function is available, for convenient use in "about" boxes and the like: `printf("%s", png_get_copyright(NULL));` Also, the PNG logo (in PNG format, of course) is supplied in the files "pngbar.png" and "pngbar.jpg"(88x31) and "pngnow.png" (98x31).

Libpng is OSI Certified Open Source Software. OSI Certified Open Source is a certification mark of the Open Source Initiative.

Glenn Randers-Pehrson
 glennrp at users.sourceforge.net
 February 18, 2008

[zlib]

This software is based in part on zlib see <http://www.zlib.net> for information.

[FreeType]

The FreeType Project is Copyright © 1996-2000 by David Turner, Robert Wilhelm, and Werner Lemberg. All rights reserved except as specified below. THE FREETYPE PROJECT IS PROVIDED "AS IS" WITHOUT WARRANTY OF ANY KIND, EITHER EXPRESS OR IMPLIED, INCLUDING, BUT NOT LIMITED TO, WARRANTIES OF MERCHANTABILITY AND FITNESS FOR A PARTICULAR PURPOSE. IN NO EVENT WILL ANY OF THE AUTHORS OR COPYRIGHT HOLDERS BE LIABLE FOR ANY DAMAGES CAUSED BY THE USE OR THE INABILITY TO USE, OF THE FREETYPE PROJECT.

[GIFLIB]

The GIFLIB distribution is Copyright © 1997 Eric S. Raymond
 THE SOFTWARE IS PROVIDED "AS IS", WITHOUT WARRANTY OF ANY KIND, EXPRESS OR IMPLIED, INCLUDING BUT NOT LIMITED TO THE WARRANTIES OF MERCHANTABILITY, FITNESS FOR A PARTICULAR PURPOSE AND NONINFRINGEMENT. IN NO EVENT SHALL THE AUTHORS OR COPYRIGHT HOLDERS BE LIABLE FOR ANY CLAIM, DAMAGES OR OTHER LIABILITY, WHETHER IN AN ACTION OF CONTRACT, TORT OR OTHERWISE, ARISING FROM, OUT OF OR IN CONNECTION WITH THE SOFTWARE OR THE USE OR OTHER DEALINGS IN THE SOFTWARE.

[TinyLogin]

This software is Copyright 1988 - 1994, Julianne Frances Haugh. All rights reserved.

[portmap]

Copyright © Sun Microsystems, Inc.

Sun RPC is a product of Sun Microsystems, Inc. and is provided for unrestricted use provided that this legend is included on all tape media and as a part of the software program in whole or part. Users may copy or modify Sun RPC without charge, but are not authorized to license or distribute it to anyone else except as part of a product or program developed by the user or with the express written consent of Sun Microsystems, Inc.

SUN RPC IS PROVIDED AS IS WITH NO WARRANTIES OF ANY KIND INCLUDING THE WARRANTIES OF DESIGN, MERCHANTABILITY AND FITNESS FOR A PARTICULAR PURPOSE, OR ARISING FROM A COURSE OF DEALING, USAGE OR TRADE PRACTICE.

Sun RPC is provided with no support and without any obligation on the part of Sun Microsystems, Inc. to assist in its use, correction, modification or enhancement.

SUN MICROSYSTEMS, INC. SHALL HAVE NO LIABILITY WITH RESPECT TO THE INFRINGEMENT OF COPYRIGHTS, TRADE SECRETS OR ANY PATENTS BY SUN RPC OR ANY PART THEREOF.

In no event will Sun Microsystems, Inc. be liable for any lost revenue or profits or other special, indirect and consequential damages, even if Sun has been advised of the possibility of such damages.

Sun Microsystems, Inc.

2550 Garcia Avenue

Mountain View, California 94043

[libpcap]

Copyright © 2000 Torsten Landschoff <torsten@debian.org>

Sebastian Kraemer <kraemer@cs.uni-potsdam.de>

License: BSD

Redistribution and use in source and binary forms, with or without modification, are permitted provided that the following conditions are met:

1. Redistributions of source code must retain the above copyright notice, this list of conditions and the following disclaimer.
2. Redistributions in binary form must reproduce the above copyright notice, this list of conditions and the following disclaimer in the documentation and/or other materials provided with the distribution.
3. The names of the authors may not be used to endorse or promote products derived from this software without specific prior written permission.

THIS SOFTWARE IS PROVIDED "AS IS" AND WITHOUT ANY EXPRESS OR IMPLIED WARRANTIES, INCLUDING, WITHOUT LIMITATION, THE IMPLIED WARRANTIES OF MERCHANTABILITY AND FITNESS FOR A PARTICULAR PURPOSE.

[libmpeg1]

Copyright © 1992 The Regents of the University of California

Copyright © 1994-1999 Gregory P. Ward <gward@python.net>

All rights reserved.

This software is supplied without even the faintest shred of assurance that it works in its entirety.

Permission to use, copy, modify, and distribute this software and its documentation for any purpose, without fee, and without written agreement is hereby granted, provided that the above copyright notice and the following two paragraphs appear in all copies of this software.

IN NO EVENT SHALL THE AUTHOR BE LIABLE TO ANY PARTY FOR DIRECT, INDIRECT, SPECIAL, INCIDENTAL, OR CONSEQUENTIAL DAMAGES ARISING OUT OF THE USE OF THIS SOFTWARE AND ITS DOCUMENTATION, EVEN IF THE UNIVERSITY OF CALIFORNIA HAS BEEN ADVISED OF THE POSSIBILITY OF SUCH DAMAGE.

THE AUTHOR SPECIFICALLY DISCLAIMS ANY WARRANTIES, INCLUDING, BUT NOT LIMITED TO, THE IMPLIED WARRANTIES OF MERCHANTABILITY AND FITNESS FOR A PARTICULAR PURPOSE. THE SOFTWARE PROVIDED

HEREUNDER IS ON AN "AS IS" BASIS, AND THE AUTHOR HAS NO BLIGATION TO PROVIDE MAINTENANCE, SUPPORT, UPDATES, ENHANCEMENTS, OR MODIFICATIONS.

[GNU GENERAL PUBLIC LICENSE]

Version 2, June 1991

Copyright © 1989, 1991 Free Software Foundation, Inc., 51 Franklin Street, Fifth Floor, Boston, MA 02110-1301 USA

Everyone is permitted to copy and distribute verbatim copies of this license document, but changing it is not allowed.

Preamble

The licenses for most software are designed to take away your freedom to share and change it. By contrast, the GNU General Public License is intended to guarantee your freedom to share and change free software - to make sure the software is free for all its users. This General Public License applies to most of the Free Software Foundation's software and to any other program whose authors commit to using it. (Some other Free Software Foundation software is covered by the GNU Lesser General Public License instead.) You can apply it to your programs, too.

When we speak of free software, we are referring to freedom, not price. Our General Public Licenses are designed to make sure that you have the freedom to distribute copies of free software (and charge for this service if you wish), that you receive source code or can get it if you want it, that you can change the software or use pieces of it in new free programs; and that you know you can do these things.

To protect your rights, we need to make restrictions that forbid anyone to deny you these rights or to ask you to surrender the rights. These restrictions translate to certain responsibilities for you if you distribute copies of the software, or if you modify it.

For example, if you distribute copies of such a program, whether gratis or for a fee, you must give the recipients all the rights that you have. You must make sure that they, too, receive or can get the source code. And you must show them these terms so they know their rights.

We protect your rights with two steps: (1) copyright the software, and (2) offer you this license which gives you legal permission to copy, distribute and/or modify the software.

Also, for each author's protection and ours, we want to make certain that everyone understands that there is no warranty for this free software. If the software is modified by someone else and passed on, we want its recipients to know that what they have is not the original, so that any problems introduced by others will not reflect on the original authors' reputations.

Finally, any free program is threatened constantly by software patents. We wish to avoid the danger that redistributors of a free program will individually obtain patent licenses, in effect making the program proprietary. To prevent this, we have made it clear that any patent must be licensed for everyone's free use or not licensed at all.

The precise terms and conditions for copying, distribution and modification follow.

GNU GENERAL PUBLIC LICENSE

TERMS AND CONDITIONS FOR COPYING, DISTRIBUTION AND MODIFICATION

0. This License applies to any program or other work which contains a notice placed by the copyright holder saying it may be distributed under the terms of this General Public License. The "Program", below, refers to any such program or work, and a "work based on the Program" means either the Program or any derivative work under copyright law: that is to say, a work containing the Program or a portion of it, either verbatim or with modifications and/or translated into another language. (Hereinafter, translation is included without limitation in the term "modification".) Each licensee is addressed as "you". Activities other than copying, distribution and modification are not covered by this License; they are outside its scope. The act of running the Program is not restricted, and the output from the Program is covered only if its contents constitute a work based on the Program (independent of having been made by running the Program). Whether that is true depends on what the Program does.
1. You may copy and distribute verbatim copies of the Program's source code as you receive it, in any medium, provided that you conspicuously and appropriately publish on each copy an appropriate copyright notice and disclaimer of warranty; keep intact all the notices that refer to this License and to the absence of any warranty; and give any other recipients of the Program a copy of this License along with the Program. You may charge a

- fee for the physical act of transferring a copy, and you may at your option offer warranty protection in exchange for a fee.
2. You may modify your copy or copies of the Program or any portion of it, thus forming a work based on the Program, and copy and distribute such modifications or work under the terms of Section 1 above, provided that you also meet all of these conditions:
 - a) You must cause the modified files to carry prominent notices stating that you changed the files and the date of any change.
 - b) You must cause any work that you distribute or publish, that in whole or in part contains or is derived from the Program or any part thereof, to be licensed as a whole at no charge to all third parties under the terms of this License.
 - c) If the modified program normally reads commands interactively when run, you must cause it, when started running for such interactive use in the most ordinary way, to print or display an announcement including an appropriate copyright notice and a notice that there is no warranty (or else, saying that you provide a warranty) and that users may redistribute the program under these conditions, and telling the user how to view a copy of this License. (Exception: if the Program itself is interactive but does not normally print such an announcement, your work based on the Program is not required to print an announcement.) These requirements apply to the modified work as a whole. If identifiable sections of that work are not derived from the Program, and can be reasonably considered independent and separate works in themselves, then this License, and its terms, do not apply to those sections when you distribute them as separate works. But when you distribute the same sections as part of a whole which is a work based on the Program, the distribution of the whole must be on the terms of this License, whose permissions for other licensees extend to the entire whole, and thus to each and every part regardless of who wrote it. Thus, it is not the intent of this section to claim rights or contest your rights to work written entirely by you; rather, the intent is to exercise the right to control the distribution of derivative or collective works based on the Program. In addition, mere aggregation of another work not based on the Program with the Program (or with a work based on the Program) on a volume of a storage or distribution medium does not bring the other work under the scope of this License.
 3. You may copy and distribute the Program (or a work based on it, under Section 2) in object code or executable form under the terms of Sections 1 and 2 above provided that you also do one of the following:
 - a) Accompany it with the complete corresponding machine-readable source code, which must be distributed under the terms of Sections 1 and 2 above on a medium customarily used for software interchange; or,
 - b) Accompany it with a written offer, valid for at least three years, to give any third party, for a charge no more than your cost of physically performing source distribution, a complete machine-readable copy of the corresponding source code, to be distributed under the terms of Sections 1 and 2 above on a medium customarily used for software interchange; or, it linking proprietary applications with the library. If this is what you want to do, use the GNU Lesser General Public License instead of this License.
 - c) Accompany it with the information you received as to the offer to distribute corresponding source code. (This alternative is allowed only for noncommercial distribution and only if you received the program in object code or executable form with such an offer, in accord with Subsection b above.) The source code for a work means the preferred form of the work for making modifications to it. For an executable work, complete source code means all the source code for all modules it contains, plus any associated interface definition files, plus the scripts used to control compilation and installation of the executable. However, as a special exception, the source code distributed need not include anything that is normally distributed (in either source or binary form) with the major components (compiler, kernel, and so on) of the operating system on which the executable runs, unless that component itself accompanies the executable. If distribution of executable or object code is made by offering access to copy from a designated place, then offering equivalent access to copy the source code from the same place counts as distribution of the source code, even though third parties are not compelled to copy the source along with the object code.
 4. You may not copy, modify, sublicense, or distribute the Program except as expressly provided under this License. Any attempt otherwise to copy, modify, sublicense or distribute the Program is void, and will automatically terminate your rights under this License. However, parties who have received copies, or rights, from you under this License will not have their licenses terminated so long as such parties remain in full compliance.
 5. You are not required to accept this License, since you have not signed it. However, nothing else grants you permission to modify or distribute the Program or its derivative works. These actions are prohibited by law if you do not accept this License. Therefore, by modifying or distributing the Program (or any work based on the

Program), you indicate your acceptance of this License to do so, and all its terms and conditions for copying, distributing or modifying the Program or works based on it.

6. Each time you redistribute the Program (or any work based on the Program), the recipient automatically receives a license from the original licensor to copy, distribute or modify the Program subject to these terms and conditions. You may not impose any further restrictions on the recipients' exercise of the rights granted herein.

You are not responsible for enforcing compliance by third parties to this License.

7. If, as a consequence of a court judgment or allegation of patent infringement or for any other reason (not limited to patent issues), conditions are imposed on you (whether by court order, agreement or otherwise) that contradict the conditions of this License, they do not excuse you from the conditions of this License. If you cannot distribute so as to satisfy simultaneously your obligations under this License and any other pertinent obligations, then as a consequence you may not distribute the Program at all. For example, if a patent license would not permit royalty-free redistribution of the Program by all those who receive copies directly or indirectly through you, then the only way you could satisfy both it and this License would be to refrain entirely from distribution of the Program.

If any portion of this section is held invalid or unenforceable under any particular circumstance, the balance of the section is intended to apply and the section as a whole is intended to apply in other circumstances. It is not the purpose of this section to induce you to infringe any patents or other property right claims or to contest validity of any such claims; this section has the sole purpose of protecting the integrity of the free software distribution system, which is implemented by public license practices. Many people have made generous contributions to the wide range of software distributed through that system in reliance on consistent application of that system; it is up to the author/donor to decide if he or she is willing to distribute software through any other system and a licensee cannot impose that choice. This section is intended to make thoroughly clear what is believed to be a consequence of the rest of this License.

8. If the distribution and/or use of the Program is restricted in certain countries either by patents or by copyrighted interfaces, the original copyright holder who places the Program under this License may add an explicit geographical distribution limitation excluding those countries, so that distribution is permitted only in or among countries not thus excluded. In such case, this License incorporates the limitation as if written in the body of this License.
9. The Free Software Foundation may publish revised and/or new versions of the General Public License from time to time. Such new versions will be similar in spirit to the present version, but may differ in detail to address new problems or concerns.
Each version is given a distinguishing version number. If the Program specifies a version number of this License which applies to it and "any later version", you have the option of following the terms and conditions either of that version or of any later version published by the Free Software Foundation. If the Program does not specify a version number of this License, you may choose any version ever published by the Free Software Foundation.
10. If you wish to incorporate parts of the Program into other free programs whose distribution conditions are different, write to the author to ask for permission. For software which is copyrighted by the Free Software Foundation, write to the Free Software Foundation; we sometimes make exceptions for this. Our decision will be guided by the two goals of preserving the free status of all derivatives of our free software and of promoting the sharing and reuse of software generally.

NO WARRANTY

11. BECAUSE THE PROGRAM IS LICENSED FREE OF CHARGE, THERE IS NO WARRANTY FOR THE PROGRAM, TO THE EXTENT PERMITTED BY APPLICABLE LAW. EXCEPT WHEN OTHERWISE STATED IN WRITING THE COPYRIGHT HOLDERS AND/OR OTHER PARTIES PROVIDE THE PROGRAM "AS IS" WITHOUT WARRANTY OF ANY KIND, EITHER EXPRESSED OR IMPLIED, INCLUDING, BUT NOT LIMITED TO, THE IMPLIED WARRANTIES OF MERCHANTABILITY AND FITNESS FOR A PARTICULAR PURPOSE. THE ENTIRE RISK AS TO THE QUALITY AND PERFORMANCE OF THE PROGRAM IS WITH YOU. SHOULD THE PROGRAM PROVE DEFECTIVE, YOU ASSUME THE COST OF ALL NECESSARY SERVICING, REPAIR OR CORRECTION.
12. IN NO EVENT UNLESS REQUIRED BY APPLICABLE LAW OR AGREED TO IN WRITING WILL ANY COPYRIGHT HOLDER, OR ANY OTHER PARTY WHO MAY MODIFY AND/OR REDISTRIBUTE THE PROGRAM AS PERMITTED ABOVE, BE LIABLE TO YOU FOR DAMAGES, INCLUDING ANY GENERAL, SPECIAL, INCIDENTAL OR CONSEQUENTIAL DAMAGES ARISING OUT OF THE USE OR INABILITY TO USE THE PROGRAM (INCLUDING BUT NOT LIMITED TO LOSS OF DATA OR DATA BEING RENDERED INACCURATE OR LOSSES

SUSTAINED BY YOU OR THIRD PARTIES OR A FAILURE OF THE PROGRAM TO OPERATE WITH ANY OTHER PROGRAMS), EVEN IF SUCH HOLDER OR OTHER PARTY HAS BEEN ADVISED OF THE POSSIBILITY OF SUCH DAMAGES.

END OF TERMS AND CONDITIONS

How to Apply These Terms to Your New Programs

If you develop a new program, and you want it to be of the greatest possible use to the public, the best way to achieve this is to make it free software which everyone can redistribute and change under these terms.

To do so, attach the following notices to the program. It is safest to attach them to the start of each source file to most effectively convey the exclusion of warranty; and each file should have at least the "copyright" line and a pointer to where the full notice is found.

<one line to give the program's name and a brief idea of what it does.>

Copyright © <year> <name of author>

This program is free software; you can redistribute it and/or modify it under the terms of the GNU General Public License as published by the Free Software Foundation; either version 2 of the License, or (at your option) any later version.

This program is distributed in the hope that it will be useful, but WITHOUT ANY WARRANTY; without even the implied warranty of MERCHANTABILITY or FITNESS FOR A PARTICULAR PURPOSE. See the GNU General Public License for more details.

You should have received a copy of the GNU General Public License along with this program; if not, write to the Free Software Foundation, Inc., 51 Franklin Street, Fifth Floor, Boston, MA 02110-1301 USA.

Also add information on how to contact you by electronic and paper mail.

If the program is interactive, make it output a short notice like this when it starts in an interactive mode:

Gnomovision version 69, Copyright © year name of author

Gnomovision comes with ABSOLUTELY NO WARRANTY; for details type 'show w'. This is free software, and you are welcome to redistribute it under certain conditions; type 'show c' for details.

The hypothetical commands 'show w' and 'show c' should show the appropriate parts of the General Public License. Of course, the commands you use may be called something other than 'show w' and 'show c'; they could even be mouse-clicks or menu items - whatever suits your program.

You should also get your employer (if you work as a programmer) or your school, if any, to sign a "copyright disclaimer" for the program, if necessary. Here is a sample; alter the names:

Yoyodyne, Inc., hereby disclaims all copyright interest in the program 'Gnomovision' (which makes passes at compilers) written by James Hacker.

<signature of Ty Coon>, 1 April 1989

Ty Coon, President of Vice

This General Public License does not permit incorporating your program into proprietary programs. If your program is a subroutine library, you may consider it more useful to permit linking proprietary applications with the library. If this is what you want to do, use the GNU Lesser General Public License instead of this License.

[GNU LESSER GENERAL PUBLIC LICENSE]

Version 2.1, February 1999

Copyright © 1991, 1999 Free Software Foundation, Inc.

51 Franklin Street, Fifth Floor, Boston, MA 02110-1301 USA

Everyone is permitted to copy and distribute verbatim copies of this license document, but changing it is not allowed.

[This is the first released version of the Lesser GPL. It also counts as the successor of the GNU Library Public License, version 2, hence the version number 2.1.]

Preamble

The licenses for most software are designed to take away your freedom to share and change it. By contrast, the GNU General Public Licenses are intended to guarantee your freedom to share and change free software - to make sure the software is free for all its users. This license, the Lesser General Public License, applies to some specially designated software packages - typically libraries - of the Free Software Foundation and other authors who decide to use it. You can use it too, but we suggest you first think carefully about whether this license or the ordinary General Public License is the better strategy to use in any particular case, based on the explanations below.

When we speak of free software, we are referring to freedom of use, not price. Our General Public Licenses are designed to make sure that you have the freedom to distribute copies of free software (and charge for this service if you wish); that you receive source code or can get it if you want it; that you can change the software and use pieces of it in new free programs; and that you are informed that you can do these things.

To protect your rights, we need to make restrictions that forbid distributors to deny you these rights or to ask you to surrender these rights. These restrictions translate to certain responsibilities for you if you distribute copies of the library or if you modify it.

For example, if you distribute copies of the library, whether gratis or for a fee, you must give the recipients all the rights that we gave you. You must make sure that they, too, receive or can get the source code. If you link other code with the library, you must provide complete object files to the recipients, so that they can relink them with the library after making changes to the library and recompiling it. And you must show them these terms so they know their rights. We protect your rights with a two-step method: (1) we copyright the library, and (2) we offer you this license, which gives you legal permission to copy, distribute and/or modify the library.

To protect each distributor, we want to make it very clear that there is no warranty for the free library. Also, if the library is modified by someone else and passed on, the recipients should know that what they have is not the original version, so that the original author's reputation will not be affected by problems that might be introduced by others.

Finally, software patents pose a constant threat to the existence of any free program. We wish to make sure that a company cannot effectively restrict the users of a free program by obtaining a restrictive license from a patent holder. Therefore, we insist that any patent license obtained for a version of the library must be consistent with the full freedom of use specified in this license.

Most GNU software, including some libraries, is covered by the ordinary GNU General Public License. This license, the GNU Lesser General Public License, applies to certain designated libraries, and is quite different from the ordinary General Public License. We use this license for certain libraries in order to permit linking those libraries into non-free programs.

When a program is linked with a library, whether statically or using a shared library, the combination of the two is legally speaking a combined work, a derivative of the original library. The ordinary General Public License therefore permits such linking only if the entire combination fits its criteria of freedom. The Lesser General Public License permits more lax criteria for linking other code with the library.

We call this license the "Lesser" General Public License because it does Less to protect the user's freedom than the ordinary General Public License. It also provides other free software developers Less of an advantage over competing non-free programs. These disadvantages are the reason we use the ordinary General Public License for many libraries. However, the Lesser license provides advantages in certain special circumstances.

For example, on rare occasions, there may be a special need to encourage the widest possible use of a certain library, so that it becomes a de-facto standard. To achieve this, non-free programs must be allowed to use the library. A more frequent case is that a free library does the same job as widely used non-free libraries. In this case, there is little to gain by limiting the free library to free software only, so we use the Lesser General Public License. In other cases, permission to use a particular library in non-free programs enables a greater number of people to use a large body of free software. For example, permission to use the GNU C Library in non-free programs enables many more people to use the whole GNU operating system, as well as its variant, the GNU Linux operating system. Although the Lesser General Public License is Less protective of the users' freedom, it does ensure that the user of a program that is linked with the Library has the freedom and the wherewithal to run that program using a modified version of the Library.

The precise terms and conditions for copying, distribution and modification follow. Pay close attention to the difference between a "work based on the library" and a "work that uses the library". The former contains code derived from the library, whereas the latter must be combined with the library in order to run.

GNU LESSER GENERAL PUBLIC LICENSE

TERMS AND CONDITIONS FOR COPYING, DISTRIBUTION AND MODIFICATION

0. This License Agreement applies to any software library or other program which contains a notice placed by the copyright holder or other authorized party saying it may be distributed under the terms of this Lesser General Public License (also called "this License"). Each licensee is addressed as "you".

A "library" means a collection of software functions and/or data prepared so as to be conveniently linked with application programs (which use some of those functions and data) to form executables.

The "Library", below, refers to any such software library or work which has been distributed under these terms.

A "work based on the Library" means either the Library or any derivative work under copyright law: that is to say, a work containing the Library or a portion of it, either verbatim or with modifications and/or translated straightforwardly into another language. (Hereinafter, translation is included without limitation in the term "modification".)

"Source code" for a work means the preferred form of the work for making modifications to it. For a library, complete source code means all the source code for all modules it contains, plus any associated interface definition files, plus the scripts used to control compilation and installation of the library.

Activities other than copying, distribution and modification are not covered by this License; they are outside its scope. The act of running a program using the Library is not restricted, and output from such a program is covered only if its contents constitute a work based on the Library (independent of the use of the Library in a tool for writing it). Whether that is true depends on what the Library does and what the program that uses the Library does.

1. You may copy and distribute verbatim copies of the Library's complete source code as you receive it, in any medium, provided that you conspicuously and appropriately publish on each copy an appropriate copyright notice and disclaimer of warranty; keep intact all the notices that refer to this License and to the absence of any warranty; and distribute a copy of this License along with the Library.

You may charge a fee for the physical act of transferring a copy, and you may at your option offer warranty protection in exchange for a fee.

2. You may modify your copy or copies of the Library or any portion of it, thus forming a work based on the Library, and copy and distribute such modifications or work under the terms of Section 1 above, provided that you also meet all of these conditions:

- a) The modified work must itself be a software library.
- b) You must cause the files modified to carry prominent notices stating that you changed the files and the date of any change.
- c) You must cause the whole of the work to be licensed at no charge to all third parties under the terms of this License.
- d) If a facility in the modified Library refers to a function or a table of data to be supplied by an application program that uses the facility, other than as an argument passed when the facility is invoked, then you must make a good faith effort to ensure that, in the event an application does not supply such function or table, the facility still operates, and performs whatever part of its purpose remains meaningful. (For example, a function in a library to compute square roots has a purpose that is entirely well-defined independent of the application. Therefore, Subsection 2d requires that any application-supplied function or table used by this function must be optional: if the application does not supply it, the square root function must still compute square roots.)

These requirements apply to the modified work as a whole. If identifiable sections of that work are not derived from the Library, and can be reasonably considered independent and separate works in themselves, then this License, and its terms, do not apply to those sections when you distribute them as separate works. But when you distribute the same sections as part of a whole which is a work based on the Library, the distribution of the whole must be on the terms of this License, whose permissions for other licensees extend to the entire whole, and thus to each and every part regardless of who wrote it.

Thus, it is not the intent of this section to claim rights or contest your rights to work written entirely by you; rather, the intent is to exercise the right to control the distribution of derivative or collective works based on the Library.

In addition, mere aggregation of another work not based on the Library with the Library (or with a work based on the Library) on a volume of a storage or distribution medium does not bring the other work under the scope of this License.

3. You may opt to apply the terms of the ordinary GNU General Public License instead of this License to a given copy of the Library. To do this, you must alter all the notices that refer to this License, so that they refer to the

ordinary GNU General Public License, version 2, instead of to this License. (If a newer version than version 2 of the ordinary GNU General Public License has appeared, then you can specify that version instead if you wish.) Do not make any other change in these notices.

Once this change is made in a given copy, it is irreversible for that copy, so the ordinary GNU General Public License applies to all subsequent copies and derivative works made from that copy. This option is useful when you wish to copy part of the code of the Library into a program that is not a library.

4. You may copy and distribute the Library (or a portion or derivative of it, under Section 2) in object code or executable form under the terms of Sections 1 and 2 above provided that you accompany it with the complete corresponding machine-readable source code, which must be distributed under the terms of Sections 1 and 2 above on a medium customarily used for software interchange.

If distribution of object code is made by offering access to copy from a designated place, then offering equivalent access to copy the source code from the same place satisfies the requirement to distribute the source code, even though third parties are not compelled to copy the source along with the object code.

5. A program that contains no derivative of any portion of the Library, but is designed to work with the Library by being compiled or linked with it, is called a “work that uses the Library”. Such a work, in isolation, is not a derivative work of the Library, and therefore falls outside the scope of this License.

However, linking a “work that uses the Library” with the Library creates an executable that is a derivative of the Library (because it contains portions of the Library), rather than a “work that uses the library”. The executable is therefore covered by this License. Section 6 states terms for distribution of such executables.

When a “work that uses the Library” uses material from a header file that is part of the Library, the object code for the work may be a derivative work of the Library even though the source code is not. Whether this is true is especially significant if the work can be linked without the Library, or if the work is itself a library. The threshold for this to be true is not precisely defined by law.

If such an object file uses only numerical parameters, data structure layouts and accessors, and small macros and small inline functions (ten lines or less in length), then the use of the object file is unrestricted, regardless of whether it is legally a derivative work. (Executables containing this object code plus portions of the Library will still fall under Section 6.)

Otherwise, if the work is a derivative of the Library, you may distribute the object code for the work under the terms of Section 6. Any executables containing that work also fall under Section 6, whether or not they are linked directly with the Library itself.

6. As an exception to the Sections above, you may also combine or link a “work that uses the Library” with the Library to produce a work containing portions of the Library, and distribute that work under terms of your choice, provided that the terms permit modification of the work for the customer’s own use and reverse engineering for debugging such modifications.

You must give prominent notice with each copy of the work that the Library is used in it and that the Library and its use are covered by this License. You must supply a copy of this License. If the work during execution displays copyright notices, you must include the copyright notice for the Library among them, as well as a reference directing the user to the copy of this License. Also, you must do one of these things:

- a) Accompany the work with the complete corresponding machine-readable source code for the Library including whatever changes were used in the work (which must be distributed under Sections 1 and 2 above); and, if the work is an executable linked with the Library, with the complete machine-readable “work that uses the Library”, as object code and/or source code, so that the user can modify the Library and then relink to produce a modified executable containing the modified Library. (It is understood that the user who changes the contents of definitions files in the Library will not necessarily be able to recompile the application to use the modified definitions.)
- b) Use a suitable shared library mechanism for linking with the Library. A suitable mechanism is one that (1) uses at run time a copy of the library already present on the user’s computer system, rather than copying library functions into the executable, and (2) will operate properly with a modified version of the library, if the user installs one, as long as the modified version is interface-compatible with the version that the work was made with.
- c) Accompany the work with a written offer, valid for at least three years, to give the same user the materials specified in Subsection 6a, above, for a charge no more than the cost of performing this distribution.
- d) If distribution of the work is made by offering access to copy from a designated place, offer equivalent access to copy the above specified materials from the same place.
- e) Verify that the user has already received a copy of these materials or that you have already sent this user a copy.

For an executable, the required form of the “work that uses the Library” must include any data and utility programs needed for reproducing the executable from it. However, as a special exception, the materials to be distributed need not include anything that is normally distributed (in either source or binary form) with the major components (compiler, kernel, and so on) of the operating system on which the executable runs, unless that component itself accompanies the executable.

It may happen that this requirement contradicts the license restrictions of other proprietary libraries that do not normally accompany the operating system. Such a contradiction means you cannot use both them and the Library together in an executable that you distribute.

7. You may place library facilities that are a work based on the Library side-by-side in a single library together with other library facilities not covered by this License, and distribute such a combined library, provided that the separate distribution of the work based on the Library and of the other library facilities is otherwise permitted, and provided that you do these two things:
 - a) Accompany the combined library with a copy of the same work based on the Library, uncombined with any other library facilities. This must be distributed under the terms of the Sections above.
 - b) Give prominent notice with the combined library of the fact that part of it is a work based on the Library, and explaining where to find the accompanying uncombined form of the same work.
8. You may not copy, modify, sublicense, link with, or distribute the Library except as expressly provided under this License. Any attempt otherwise to copy, modify, sublicense, link with, or distribute the Library is void, and will automatically terminate your rights under this License. However, parties who have received copies, or rights, from you under this License will not have their licenses terminated so long as such parties remain in full compliance.
9. You are not required to accept this License, since you have not signed it. However, nothing else grants you permission to modify or distribute the Library or its derivative works. These actions are prohibited by law if you do not accept this License. Therefore, by modifying or distributing the Library (or any work based on the Library), you indicate your acceptance of this License to do so, and all its terms and conditions for copying, distributing or modifying the Library or works based on it.
10. Each time you redistribute the Library (or any work based on the Library), the recipient automatically receives a license from the original licensor to copy, distribute, link with or modify the Library subject to these terms and conditions. You may not impose any further restrictions on the recipients' exercise of the rights granted herein. You are not responsible for enforcing compliance by third parties with this License.
11. If, as a consequence of a court judgment or allegation of patent infringement or for any other reason (not limited to patent issues), conditions are imposed on you (whether by court order, agreement or otherwise) that contradict the conditions of this License, they do not excuse you from the conditions of this License. If you cannot distribute so as to satisfy simultaneously your obligations under this License and any other pertinent obligations, then as a consequence you may not distribute the Library at all. For example, if a patent license would not permit royalty-free redistribution of the Library by all those who receive copies directly or indirectly through you, then the only way you could satisfy both it and this License would be to refrain entirely from distribution of the Library. If any portion of this section is held invalid or unenforceable under any particular circumstance, the balance of the section is intended to apply, and the section as a whole is intended to apply in other circumstances.

It is not the purpose of this section to induce you to infringe any patents or other property right claims or to contest validity of any such claims; this section has the sole purpose of protecting the integrity of the free software distribution system which is implemented by public license practices. Many people have made generous contributions to the wide range of software distributed through that system in reliance on consistent application of that system; it is up to the author donor to decide if he or she is willing to distribute software through any other system and a licensee cannot impose that choice.

This section is intended to make thoroughly clear what is believed to be a consequence of the rest of this License.
12. If the distribution and/or use of the Library is restricted in certain countries either by patents or by copyrighted interfaces, the original copyright holder who places the Library under this License may add an explicit geographical distribution limitation excluding those countries, so that distribution is permitted only in or among countries not thus excluded. In such case, this License incorporates the limitation as if written in the body of this License.
13. The Free Software Foundation may publish revised and/or new versions of the Lesser General Public License from time to time. Such new versions will be similar in spirit to the present version, but may differ in detail to address new problems or concerns.

Each version is given a distinguishing version number. If the Library specifies a version number of this License which applies to it and “any later version”, you have the option of following the terms and conditions either of that version or of any later version published by the Free Software Foundation. If the Library does not specify a license version number, you may choose any version ever published by the Free Software Foundation.

14. If you wish to incorporate parts of the Library into other free programs whose distribution conditions are incompatible with these, write to the author to ask for permission. For software which is copyrighted by the Free Software Foundation, write to the Free Software Foundation; we sometimes make exceptions for this. Our decision will be guided by the two goals of preserving the free status of all derivatives of our free software and of promoting the sharing and reuse of software generally.

NO WARRANTY

15. BECAUSE THE LIBRARY IS LICENSED FREE OF CHARGE, THERE IS NO WARRANTY FOR THE LIBRARY, TO THE EXTENT PERMITTED BY APPLICABLE LAW. EXCEPT WHEN OTHERWISE STATED IN WRITING THE COPYRIGHT HOLDERS AND/OR OTHER PARTIES PROVIDE THE LIBRARY “AS IS” WITHOUT WARRANTY OF ANY KIND, EITHER EXPRESSED OR IMPLIED, INCLUDING, BUT NOT LIMITED TO, THE IMPLIED WARRANTIES OF MERCHANTABILITY AND FITNESS FOR A PARTICULAR PURPOSE. THE ENTIRE RISK AS TO THE QUALITY AND PERFORMANCE OF THE LIBRARY IS WITH YOU. SHOULD THE LIBRARY PROVE DEFECTIVE, YOU ASSUME THE COST OF ALL NECESSARY SERVICING, REPAIR OR CORRECTION.
16. IN NO EVENT UNLESS REQUIRED BY APPLICABLE LAW OR AGREED TO IN WRITING WILL ANY COPYRIGHT HOLDER, OR ANY OTHER PARTY WHO MAY MODIFY AND/OR REDISTRIBUTE THE LIBRARY AS PERMITTED ABOVE, BE LIABLE TO YOU FOR DAMAGES, INCLUDING ANY GENERAL, SPECIAL, INCIDENTAL OR CONSEQUENTIAL DAMAGES ARISING OUT OF THE USE OR INABILITY TO USE THE LIBRARY (INCLUDING BUT NOT LIMITED TO LOSS OF DATA OR DATA BEING RENDERED INACCURATE OR LOSSES SUSTAINED BY YOU OR THIRD PARTIES OR A FAILURE OF THE LIBRARY TO OPERATE WITH ANY OTHER SOFTWARE), EVEN IF SUCH HOLDER OR OTHER PARTY HAS BEEN ADVISED OF THE POSSIBILITY OF SUCH DAMAGES.
- END OF TERMS AND CONDITIONS

How to Apply These Terms to Your New Libraries

If you develop a new library, and you want it to be of the greatest possible use to the public, we recommend making it free software that everyone can redistribute and change. You can do so by permitting redistribution under these terms (or, alternatively, under the terms of the ordinary General Public License).

To apply these terms, attach the following notices to the library. It is safest to attach them to the start of each source file to most effectively convey the exclusion of warranty; and each file should have at least the “copyright” line and a pointer to where the full notice is found.

<one line to give the library’s name and a brief idea of what it does.>

Copyright © <year> <name of author>

This library is free software; you can redistribute it and/or modify it under the terms of the GNU Lesser General Public License as published by the Free Software Foundation; either version 2.1 of the License, or (at your option) any later version.

This library is distributed in the hope that it will be useful, but WITHOUT ANY WARRANTY; without even the implied warranty of MERCHANTABILITY or FITNESS FOR A PARTICULAR PURPOSE. See the GNU Lesser General Public License for more details.

You should have received a copy of the GNU Lesser General Public License along with this library; if not, write to the Free Software Foundation, Inc., 51 Franklin Street, Fifth Floor, Boston, MA 02110-1301 USA

Also add information on how to contact you by electronic and paper mail.

You should also get your employer (if you work as a programmer) or your school, if any, to sign a “copyright disclaimer” for the library, if necessary. Here is a sample; alter the names:

Yoyodyne, Inc., hereby disclaims all copyright interest in the library ‘Frob’ (a library for tweaking knobs) written by James Random Hacker.

<signature of Ty Coon>, 1 April 1990

Ty Coon, President of Vice

That’s all there is to it!

[Linux Source Notice]

The software programs used on this product include the Linux operating system. The Linux contains software licensed for use based on the terms of a GNU General Public License. The machine readable copy of the corresponding source code is available for the cost of distribution.

For more information or to obtain a copy, contact your local Pioneer Customer Service center.

Details of the GNU General Public License can be found at the GNU website (<http://www.gnu.org>).

8.4 Glossary

HDMI

The High-Definition Multimedia Interface (HDMI) is a digital data transmission standard for consumer electronics/home appliances. HDMI connects digital audio/video sources to a compatible digital audio and/or video device, such as a flat panel TV. HDMI also allows digitally transmitted audio and control signals on a single cable for multi-channel digital audio sources.

PCM

The Pulse Code Modulation (PCM) is a method for converting analog audio signals to digital. PCM is used in music CDs.

Dolby Digital

Dolby Digital is an encoding technology for audio signal compressions. Dolby Digital supports high-quality, high-compression, multi-channel audio formats. The 5.1-channel surround format is utilized in digital broadcasts.

High-Definition Broadcast

HD is a digital television broadcasting system with greater resolution than traditional television systems. As compared with the existing terrestrial analog broadcasting system capable of producing an image composed of 525 lines of resolution, the digital high-definition broadcasting system features 750 or 1125 lines, thus providing higher definition and quality image.

Interlaced Scanning

In NTSC television or video image display, interlaced scanning first redraws every second line of the image field (262.5 lines) per each image refresh in 1/60 of a second, then the remaining lines with a second refresh in 1/60 of a second for a complete frame of an image (525 lines). Effective scanning lines are expressed as "480i" and "1080i" ("i" stands for "interlaced").

Progressive Scanning

The progressive scanning redraws an image frame (all of its lines) in order per each image refresh. Compared to interlaced scanning, progressive scanning produces less flicker, making it suitable for displaying text and still images. Effective scanning lines are expressed as "480p" and "720p" ("p" stands for "progressive").

(Home Media Gallery)

Default Gateway

Default gateway is a node on a computer network that serves as an access point to another network. A default gateway (such as a computer and router) is used to forward all traffic that is not addressed to a station within the local subnet.

DHCP (Dynamic Host Configuration Protocol) Server

Provides a mechanism to allocate IP addresses to client hosts. In most cases, a broadband router serves as a DHCP server in a home network.

DLNA (Digital Living Network Alliance)

The DLNA authorized logo makes it easy for consumers to recognize products that meet the new standard for home network PCs and other digital devices, as set down in the DLNA Guidelines for interoperability. This allows music, video, etc. to be enjoyed from various devices over a home network. This unit is compatible with music, photo and video content, and is based on the DLNA Home Networked Device Interoperability Guidelines - expanded: October 2006 (v1.5). This unit can be used to playback music, photos and video stored on a DLNA-compatible server connected through a LAN cable.

Digital Living Network Alliance (DLNA) is dedicated to the simplified sharing of digital content, such as digital music, photos and video among networked consumer electronics (CE) and PCs. By establishing a platform of interoperability based on open industry standards, DLNA delivers technical design guidelines that companies can use to develop digital home products that share content through wired or wireless networks in the home.

DNS (Domain Name Service) Server

DNS Server is a server that determines the name of network-computer within the Internet. The server functions to exchange IP address to the hostname, hostname to the IP address.

Ethernet

A frame-based computer networking technology for local area networks (LANs). The flat panel TV supports 100BASE-TX.

IP (Internet Protocol) Address

A unique number that devices use in order to identify and communicate with each other on a network utilizing the Internet Protocol standard, such as "192.168.1.xxx". No duplicate numbers are allowed within the network.

LAN Cable

A cable that has an eight-pin modular plug on each end and is different from a telephone plug which has four pins. A straight cable is used when connecting the flat panel TV to a home network via a hub. A cross-over cable is used when connecting directly to a PC. Use category 5 (CAT-5) LAN cables.

MAC (Media Access Control) Address

An address attached to the port of any network device with an IP address. The MAC address is expressed as "00:e0:36:01:23:xx" and cannot be changed.

Mass Storage Class Devices

The standard provides an interface to a variety of storage devices, such as USB flash drive and digital cameras.

PTP (Picture Transfer Protocol)

A protocol that allows the transfer of images and manipulation of digital cameras through USB connection. Most recent digital cameras and other devices support PTP allowing the transfer of images through direct connections.

Subnet Mask

Used to determine the network when IP addresses are broken into several parts. It is expressed as "255.255.255.0". In most cases, the Subnet mask is automatically assigned by the DHCP server.

UPnP (Universal Plug and Play)

Architecture for pervasive peer-to-peer network connectivity of devices of all form factors. It is designed to bring easy-to-use, flexible, standard based connectivity to ad-hoc or unmanaged networks whether in the home, in a small business, public spaces, or attached to the Internet.

USB (Universal Serial Bus)

USB provides a serial bus standard for connecting devices, usually to computers such as PCs. The flat panel TV supports the Mass Storage Class and PTP (Picture Transfer Protocol) devices.

Windows Media Connect

Microsoft Windows Media Connect is a new technology to distribute music, photos and video stored on a PC with Windows XP installed to a stereo system of TV. Using this technology you can playback files stored on the PC from various devices wherever you like in your home.

Windows Media DRM

Windows Media DRM is copyright protection technology developed by Microsoft Corporation. It enables content providers to distribute over the Internet music, video and other digital media content in a protected, encrypted file format.

Windows Media Player

A free digital media player application provided by Microsoft that is used for playing audio, video and images on PCs.

Windows Media Player 11

The functionality of Windows Media Connect has been integrated into this version of Windows Media Player. After installing Windows Media Player 11 Windows Media Connect will not function. See Microsoft's website for details.

8.5 Index

Numerics

100BASE-TX	85, 152
10BASE-T	85
2-screen	12, 13, 61, 62

A

Air/Cable	35
Analog	43, 64, 66, 74, 75
Analog TV Setup	36, 38, 43
Auto Installation	35, 38
Auto Size	52, 56, 59
AV Selection	54, 55
AVC	46, 67

B

Balance	33, 46, 57
Bass	33
Block	49, 51, 113
Blue	33, 58, 65
Brightness	45, 55, 58
Brightness Sync	60, 116

C

Canadian English Ratings	49
Canadian French Ratings	49
CBL	12, 71
Change Password	33, 47
Channel	35, 38, 41
Channel Mode	33, 39
Clock	35, 112
Closed Captions	64, 65
Color	42, 45, 55, 58
Contrast	43, 54, 55, 58

D

Digital	26, 32, 50
Digital Tuner Setup	35, 38, 120
Dolby Digital	111, 135

E

Energy Save	52, 53, 67
-------------------	------------

F

Favorites	33, 40
Favorites Sort	33, 40
Film Mode	60
Freeze	62, 121

G

GAME	28, 54, 56, 60, 82
Game Control Pref	56, 60
Green	58, 65, 73

H

H/V Position Adjust	44
HD Wide Mode	59
HDMI Control	74, 76, 78
HDMI Control Setting	78, 81
HDMI Input	74, 75, 114
HDMI terminal	27, 74, 76, 116
Home Media Gallery	83
HOME MENU	12, 34

I

InfoBanner	63
Input	12, 40
Installation	14, 35, 121

L

Label	40
Label Input	40
Language	34, 35, 65, 66, 76

M

Manual Adjust	36, 43
MOVIE	12, 44, 54
MPAA	48, 126
MTS	64, 66
Multi-screen	56, 61, 62
MUTING	13, 41

N

No Operation off	68
No Signal Off	68

O

OPTIMUM	12, 45, 54
Orbiter	53, 123

P

Parental Control	47, 48, 50, 113
PCM	74, 111
PERFORMANCE	12, 54
Picture-in-picture	12, 13, 61
Position	44, 112
Power	31, 53, 67
Power Control	82
Power Management	68
PureCinema	59

R

RCV	12
Red	58, 65
Remote Control	10, 12, 69
Room Light Sensor	42

S

SAP	64, 66
SAT	12, 71
Screen Protection	33, 52, 114, 123
SCREEN SIZE	13, 56
Sharpness	55, 58
SHIFT	13, 61, 62
Side Mask	52, 59, 60
Side Mask Detection	59, 123
Sleep Timer	41, 115
Sound	42, 46, 54, 64
Sound Effect	67, 135
SPORT	12, 54
SRS	67, 135, 155
SRS Definition	135
SRS FOCUS	135
SRS TruBASS	135
STANDARD	12, 55
Standard	12, 54
SWAP	13, 61, 62
System Setup	34

T

Text Optimization	60
Time Zone	35
Tint	55, 58
Treble	46
TV Parental Guidelines	48, 49, 50
TV/DTV	13, 26, 32

U

Unavailable Ratings	49
USER	12, 55

V

VOLUME	41, 67
--------------	--------

8.6 Trademarks, Licenses, & Patent Information

Trademarks



 is a trademark of SRS Labs, Inc.

WOW HD technology is incorporated under license from SRS Labs, Inc.

Manufactured under license from Dolby Laboratories. Dolby and the double-D symbol are trademarks of Dolby Laboratories. HDMI, the HDMI Logo and High-Definition Multimedia Interface are trademarks or registered trademarks of HDMI Licensing LLC.

This product includes FontAvenue® fonts licensed by NEC Corporation. FontAvenue is a registered trademark of NEC Corporation.

DDC is a registered trademark of Video Electronics Standards Association.

This software is based in part on the work of the independent JPEG Group.

The names of the companies or institutions are trademarks or registered trademarks of the respective companies or institutions.

Windows Media and the Windows logo are trademarks or registered trademarks of Microsoft Corporation in the United States and/or other countries.

DLNA and DLNA CERTIFIED are trademarks and/or service marks of Digital Living Network Alliance.

License

Content owners use Windows Media digital rights management technology (WMDRM) to protect their intellectual property, including copyrights. This device uses WMDRM software to access WMDRM-protected content. If the WMDRM software fails to protect the content, content owners may ask Microsoft to revoke the software's ability to use WMDRM to play or copy protected content. Revocation does not affect unprotected content. When you download licenses for protected content, you agree that Microsoft may include a revocation list with the licenses. Content owners may require you to upgrade WMDRM to access their content. If you decline an upgrade, you will not be able to access content that requires the upgrade.

This product is protected by certain intellectual property rights of Microsoft. Use or distribution of such technology outside of this product is prohibited without a license from Microsoft.

The DLNA logo is permitted to the product that has obtained a DLNA (Digital Living Network Alliance) certificate.

Disclaimer Notice

Pioneer provides information to help in setting up a network and connecting the flat panel TV to the network, but you are solely responsible for proper network setup and the connection. Pioneer bears no responsibility whatsoever for any damage arising from the network setup and the connection you made.

When downloading software updates from the Pioneer website and performing updating procedures, make sure that your connections from the network to your USB flash drive, and from your USB flash drive to the flat panel TV are uninterrupted. Pioneer bears no responsibility for any failures or damage resulting from connection problems.

Content may not work properly depending on the USB device used. Pioneer assumes no responsibility whatsoever for any failures or damage resulting from the USB device used by the user.

Free Manuals Download Website

<http://myh66.com>

<http://usermanuals.us>

<http://www.somanuals.com>

<http://www.4manuals.cc>

<http://www.manual-lib.com>

<http://www.404manual.com>

<http://www.luxmanual.com>

<http://aubethermostatmanual.com>

Golf course search by state

<http://golfingnear.com>

Email search by domain

<http://emailbydomain.com>

Auto manuals search

<http://auto.somanuals.com>

TV manuals search

<http://tv.somanuals.com>